

**2008K  
LEVEL I  
TRAINING**



**FRESENIUS  
MEDICAL CARE**





**FRESENIUS  
MEDICAL CARE**

**2008<sup>®</sup> K LEVEL I**

**TRAINING MANUAL**

**Part Number 490114 Rev. E**

**Fresenius Medical Care North America  
920 Winter St.  
Waltham, MA 02451**

**Manufactured by:  
Fresenius USA, Inc.  
4040 Nelson Avenue  
Concord, CA 94520**

**<http://www.fmcna.com>**

The 2008K and 2008K<sup>2</sup> are indicated for acute and chronic dialysis therapy.

**Caution:** Federal (US) law restricts these devices to sale by or on the order of a physician or other licensed practitioner. Read the Instructions for Use for safe and proper use of these devices. For a complete description of hazards, contraindications, side effects and precautions, see full package labeling at:

<http://fmcna.com/fmcna/ProductsSupportDocumentation/products-support-documentation.html>

©2010 - 2014 Fresenius Medical Care North America, all rights reserved

Fresenius Medical Care, the triangle logo, 2008 and Diasafe are trademarks of Fresenius Medical Care Holdings, Inc. or its affiliated companies.

All other trademarks are the property of their respective owners.

## **TABLE OF CONTENTS**

- I 2008K TRAINING COURSE AGENDA
- II HEMODIALYSIS REVIEW
- III HYDRAULIC DESCRIPTION
- IV MACHINE OPERATION
- V INSTALLATION CHECKLIST INSTRUCTIONS
- VI ELECTRONIC CIRCUIT BOARD REVIEW
- VII ALARMS & PRESSURE HOLDING TESTS
- VIII ON-LINE PRESSURE HOLDING TEST
- IX TROUBLESHOOTING PRESSURE HOLDING TESTS
- X NOTES



**SECTION I**

**2008K TRAINING  
COURSE AGENDA**





# **2008K Training Course Agenda**

Hydraulics Theory

Machine operation

Electronics & Modules

Preventative Maintenance

Rebuilds and Repairs

Calibrations

Students that successfully complete the class should have a thorough understanding of the hydraulic system and be able to troubleshoot minor problems, do all calibrations, and perform the preventive maintenance procedures.

\*NOTE\* - Actual agenda may vary in order of items covered from printed agenda.

**NOTES**

---

---

---

---

---

---

---

---

---

---

---

---

---

---

---

---

---

---

---

---

---

---

---

---

**SECTION II**

**HEMODIALYSIS REVIEW**



## KIDNEY PHYSIOLOGY

Humans have two kidneys located on either side of the spinal column in the back. Each kidney is about the size of an adult fist and is padded against injury by fat and muscle. The body's total blood volume circulates through the kidneys about 12 times every hour.

*Nephrons* are the working units of the kidneys functioning as blood purification filters. Each kidney has nearly one million of them. Each *nephron* contains a *glomerulus* which consists of a tangled ball of *capillaries* (the body's smallest blood vessels). The walls of the capillaries contain small pores (holes) to allow small molecules to pass through while restricting the passage of larger molecules such as blood cells and protein. This is called *selective permeability*. Blood, containing the waste products of cellular *metabolism*, is delivered to the *nephrons* to be filtered.

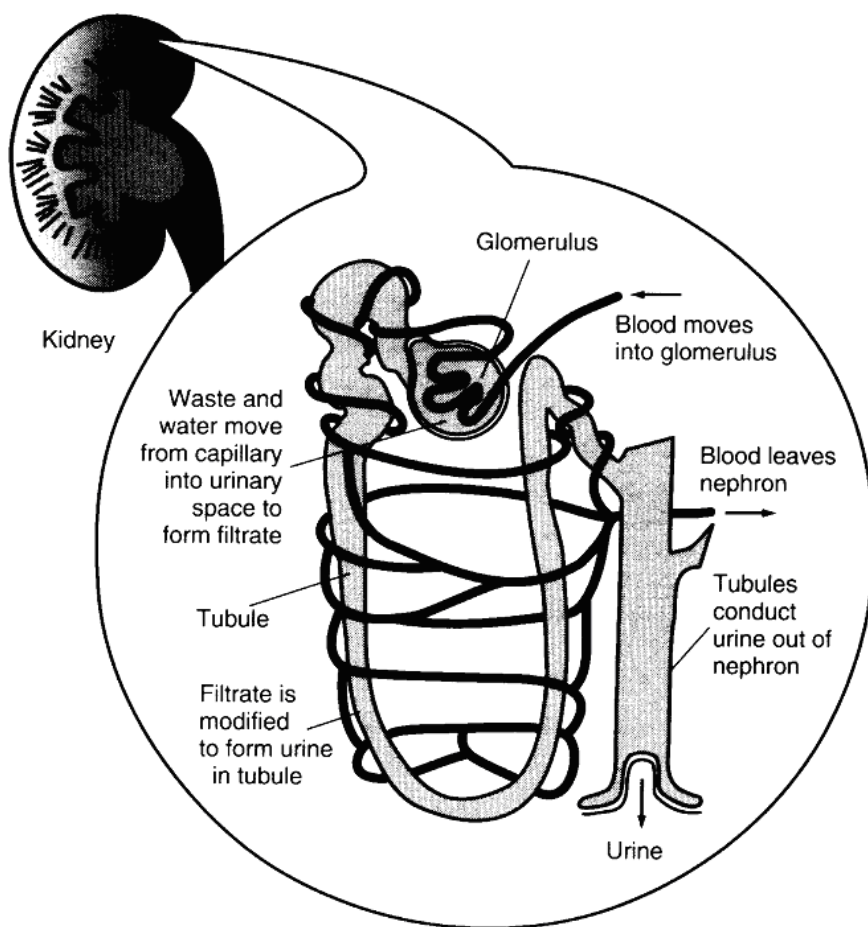

DIAGRAM 2.1 THE NEPHRON <sup>1</sup>

<sup>1</sup> AMGEN Inc. A Comprehensive Review of Hemodialysis. Core Curriculum for the Dialysis Technician. Second Edition, 1998.

## **KIDNEY FUNCTION**

The kidneys have several functions:

### •WATER BALANCE

Water accounts for about 60% of the total body weight of adults and is conserved or excreted as needed by the kidneys. Two thirds of the body's water is inside the cells which are surrounded by a membrane to keep them separated from other cells. The remaining one third flows around the cells. Cell membranes are freely permeable to water but *selectively permeable* to certain dissolved particles (solutes).

### •WASTE REMOVAL

When the glomerulus filters the blood, a watery fluid (*filtrate*) results which contains metabolic waste, essential solutes (such as sodium and potassium) and large volumes of water. Healthy kidneys reabsorb much of the water and essential solutes and return it to the blood. What remains is very *concentrated* and removed, along with water, as urine. Removed solutes include electrically charged particles (*ions* or *electrolytes*) as well as uncharged particles (*urea*). For every 100 ml of filtrate produced about 1 ml of urine results. Healthy kidneys produce about 1 ml of urine per minute or about 1440 ml in 24 hours depending on hydration status. The final volume of urine depends on the amount of water the body must eliminate to maintain its normal environment.

### •MAINTAINANCE OF ELECTROLYTE BALANCE

The body needs precise levels of certain ions (or electrolytes) to be present in the blood to maintain normal cellular function. The kidneys help to keep the body's ionic balance normal.

### •ACID-BASE BALANCE (expressed as pH)

As the body breaks down and uses proteins and other substances, acids are created. The lungs help balance the body's pH by expelling carbon dioxide. The kidneys excrete hydrogen atoms as well as produce *bicarbonate* (a base). Normal blood pH is about 7.4.

### •HORMONE PRODUCTION

The kidneys produce *hormones* (substances that act on other parts of the body). One renal hormone regulates blood pressure. Another, *erythropoietin* acts on the bone marrow to replace dead red blood cells.

## **KIDNEY FAILURE**

Kidney (renal) failure is determined by carefully monitoring the *glomerular filtration rate* (GFR). The GFR is the volume of blood (in ml) filtered by the glomerulus each minute. A normal GFR is 90 - 120 ml/min/1.73 m<sup>2</sup>. A renal patient whose GFR has dropped to about 15ml/min/1.73 m<sup>2</sup> has *end stage renal disease* (ESRD) and needs renal replacement therapy (such as *Hemodialysis*(HD), *Peritoneal Dialysis* (PD) or a kidney transplant) to remain alive.

## **HEMODIALYSIS**

The HEMODIALYSIS process removes excess water and wastes through artificial, hollow fiber (straw-like), *semipermeable* membranes that are encased in a plastic housing. This assembly is commonly called a *dialyzer* (artificial kidney). Like the capillary vessels in the glomerulus the dialyzer membranes are *selectively permeable*.

The membrane's *permeability* defines its ability to allow solutes of different sizes to pass through. Smaller solutes, such as electrolytes and creatinine or middle sized solutes, such as vitamin B<sub>12</sub> can pass through most dialyzer membranes. Particles, such as blood cells, bacteria, viruses, and protein cannot. Depending on the membrane's permeability, some larger molecules such as beta-2-microglobulin (B2M) can also pass through.

To perform a HEMODIALYSIS treatment a fluid mixture called *dialysate* is prepared which contains electrolytes (or ions) in concentrations, usually similar to human blood. The dialysate's composition determines which solutes pass through the membranes or remain in the blood. Dialysate and blood is pumped through two separate compartments in the dialyzer.

## **THE DIALYZER**

The DIALYZER consists of two compartments (see Diagram 2.2).

### **•BLOOD COMPARTMENT**

Consists of thousands of hollow fiber semipermeable membranes. Each fiber is about the circumference of a strand of hair. The patient's blood is delivered through the fibers and then returned to the patient.

### **•DIALYSATE COMPARTMENT**

Allows dialysate to flow through the dialyzer where it surrounds the fibers flowing over and around them. The semipermeable membrane keeps the blood and dialysate separated while allowing only certain solutes and electrolytes to pass through, depending on their size and the concentration gradient (difference) between the blood and dialysate compartments.

### **•FLOW GEOMETRY**

Fluid flow during dialysis is countercurrent. Blood flows through the dialyzer in one direction and the dialysate flows in the opposite direction. This countercurrent flow aids in the diffusion process by keeping a high concentration gradient across the dialyzer membrane.

Section II – Hemodialysis Review

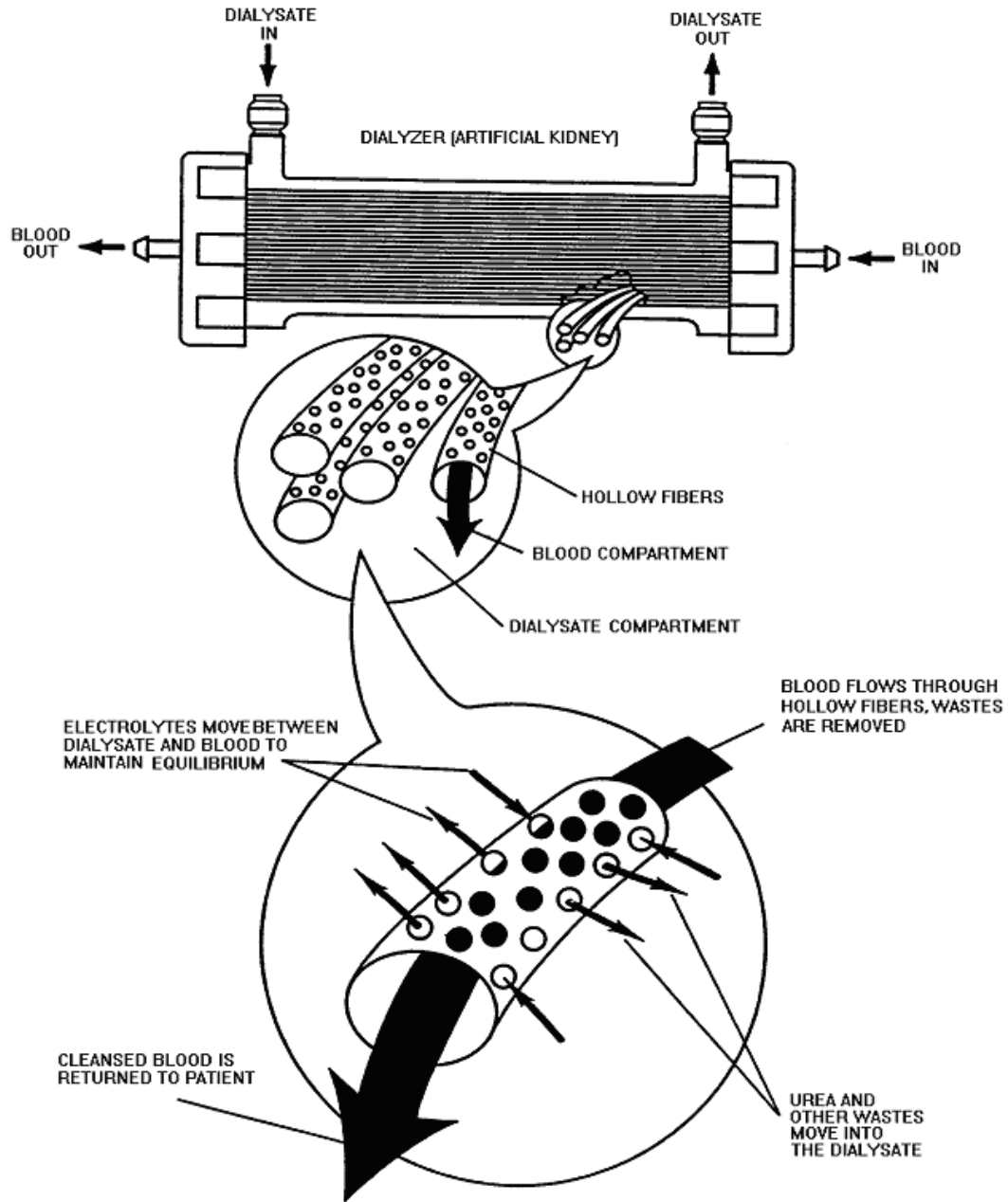

**DIAGRAM 2.2 THE DIALYZER<sup>1</sup>**

<sup>1</sup> AMGEN Inc. A Comprehensive Review of Hemodialysis. Core Curriculum for the Dialysis Technician. Second Edition, 1998.



**DIALYSATE**

Dialysate begins with a concentrated salt solution containing precise amounts of sodium chloride (NaCl), potassium chloride (KCl), magnesium chloride (MgCl), calcium chloride (CaCl). In some cases glucose (sugar) is also included. The salt solution is most commonly buffered with sodium bicarbonate. The buffered salt solution is called *concentrate*, which is mixed with treated water and heated to near human body temperature (37°C). In water, concentrate dissolves into *ions* (atomic particles that carry electric charges). The ionic solution is called *dialysate*. The human body requires precise ionic levels to maintain proper electrical nerve conduction as well as other normal physiological functions.

Inside the dialyzer an equilibrium (balancing) process occurs. If the membrane is permeable to a molecule, diffusion of that molecule across the membrane will occur until equilibrium is achieved between both sides of the membrane. If the membrane is not permeable to a molecule, osmosis will occur. Water will move to the side of higher concentration of the non-permeable molecule.

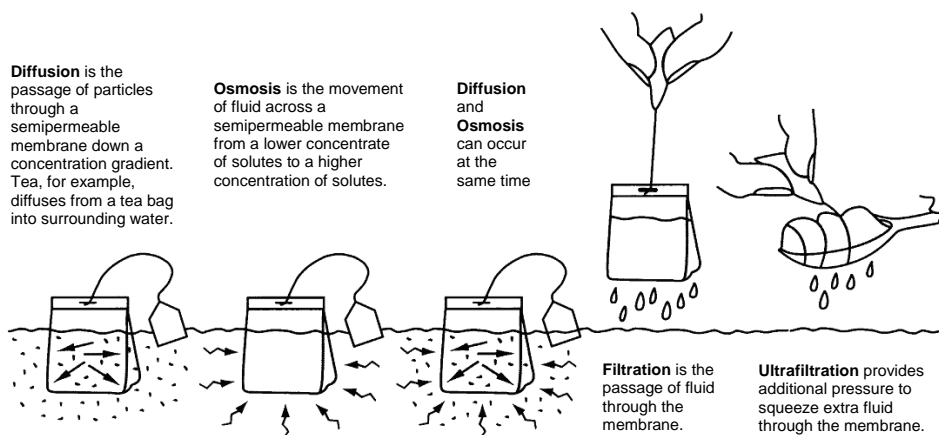

**DIAGRAM 2.3 DIFFUSION AND OSMOSIS**

**BLOOD AND DIALYSATE ELECTROLYTES<sup>1</sup>**

Electrolyte	Ionic Symbol (in Dialysate)	Normal Physiological Range	Typical Dialysate Range
Sodium	Na <sup>+</sup>	135 to 145 mEq/L	135 to 145 mEq/L
Potassium	K <sup>+</sup>	3.5 to 5.5 mEq/L	0 to 4 mEq/L
Calcium	Ca <sup>++</sup>	4.5 to 5.5 mEq/L	2.5 to 3.5 mEq/L
Magnesium	Mg <sup>++</sup>	1.5 to 2.5 mEq/L	0.5 to 1.5 mEq/L
Chloride	Cl <sup>-</sup>	95 to 105 mEq/L	104 to 108 mEq/L

<sup>1</sup> AMGEN Inc. A comprehensive review of hemodialysis. Core Curriculum for the Dialysis Technician. Second Edition, 1998.

## THE HEMODIALYSIS MACHINE

The HEMODIALYSIS MACHINE performs four major functions:

1. PREPARES AND MONITORS DIALYSATE
2. MONITORS THE PATIENT 'BLOOD CIRCUIT'
3. CONTROLS 'DIALYSATE CIRCUIT' FLOW
4. REMOVES WATER (ULTRAFILTRATE) FROM THE PATIENT'S BLOOD

### 1. PREPARES AND MONITORS DIALYSATE

Dialysate is prepared by mixing a buffered, concentrated salt solution (concentrate) with treated water. Its ionic concentration and temperature must be precisely controlled to be compatible with human blood.

- a) Precise volumes of concentrate are pumped into the machine and mixed with precise volumes of treated water. Ionic concentration is controlled by the amount of concentrate. The volume components can be expressed mathematically as:
  - If buffered with sodium bicarbonate:  $A + B + W = \text{DIALYSATE}$   
Where 'A' = Acid Concentrate, 'B' = Bicarbonate Concentrate and 'W' = water
- b) Ions carry electrical charge giving dialysate the ability to conduct *current*. As the concentration of ions increase the ability to conduct increases. *Conductivity* is a measurement of current flow which indicates total ionic content. Conductivity units are milliSiemens (mS). Base values are typically between 13.5 and 14.5 mS.
- c) A heater is controlled to maintain TEMPERATURE near human body temperature. Temperature values are measured in degrees Celsius (°C). Body temperature is 37°C
- d) Temperature and conductivity *actual* values are monitored by sensors pre-dialyzer. Both *actual* values are compared to safe physiological *limit* values that are maintained by the machine. If a conductivity or temperature *actual* value violates a limit value dialysate is not allowed to flow to the dialyzer. This condition is known as BYPASS.

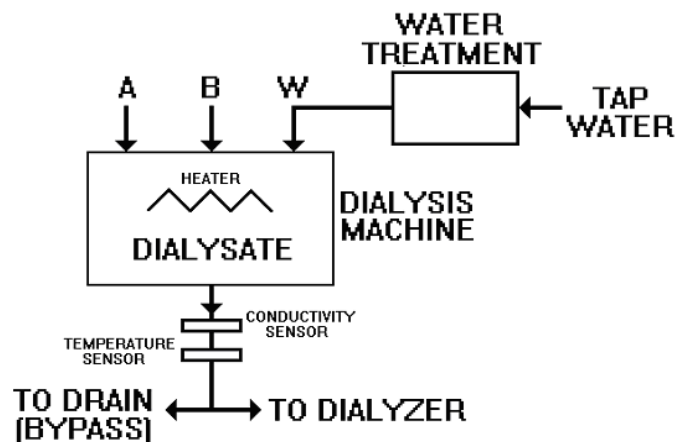

DIAGRAM 2.4 DIALYSATE PREPARATION

## 2. MONITORS THE PATIENT 'BLOOD CIRCUIT'

The 'BLOOD CIRCUIT' consists of the patient, the dialyzer's *blood compartment*, arterial and venous blood tubing and the blood pump.

- a) The patient's circulatory (blood) system must be accessed through both an artery and a vein. Although it is easy to draw blood from regular veins there is inadequate pressure and flow for hemodialysis to occur. It takes five or six complete exchanges of a person's total blood volume to adequately dialyze them! Gaining access to the patient's circulatory system was a major breakthrough making chronic (repeated) dialysis possible. Types of patient accesses are:
  - ARTERIOVENOUS FISTULAS, a permanent surgical connection between an existing vein and artery inside an arm or a leg.
  - GRAFTS, a surgically implanted artificial device that connects arteries and veins together. It is most commonly made of polytetrafluorethylene (a plastic).
  - CATHETER, surgically inserted into a deep central vein usually within the groin area, upper neck or chest.
- b) During the hemodialysis treatment the patient's blood is transported throughout the BLOOD CIRCUIT with tubing. There are two tubing segments, *arterial* and *venous*, that are independent of each other. The *arterial* tubing (color coded red) carries blood away from the patient and delivers it to the dialyzer. The *venous* tubing (color coded blue) carries blood from the dialyzer back to the patient. The diameter of the tubing is small so that only small amounts of blood (about 200 ml with adults) are outside the patient's body at any given time.
- c) The arterial tubing consists of a *blood pump segment*, *luer lock patient* and *dialyzer connectors*, and *drip chamber*. The *blood pump segment* is a durable, less flexible part of the tubing that is threaded through the blood pump's roller mechanism. The *blood pump* transports blood through the BLOOD CIRCUIT at a rate prescribed by the physician. *Drip chambers* trap air that may have accidentally entered the circuit. They also provide lines that can be connected to an electronic pressure transducer.
- d) The venous tubing consists of *luer lock patient* and *dialyzer connectors* and a *drip chamber*. Usually there is a very fine mesh screen inside the venous drip chamber to catch blood clots. The chamber is placed inside the *air/foam detector*, between an ultrasonic (sound) transmitter and receiver located in the *level detector module*. Sound travels differently through air than through blood and in this way air can be detected. Air entering the patient can cause embolisms and death.
- e) With fistula or grafts the patient's vascular system is accessed with needles that are connected to the 'patient side' of blood tubing. The needles (most often 15 or 16 gauge) are inserted into the fistula or graft so that one points towards the patient's artery while the other points towards the vein. The needles are ideally separated by at least two inches to minimize recirculation between them. With catheters the blood tubing is connected directly to the catheter's access sites.

## Section II – Hemodialysis Review

- f) BLOOD CIRCUIT pressures are a function of blood flow and the resistance to that flow due to the patient's vascular access, needles, blood lines and the dialyzer. Pressure monitoring lines are provided at the arterial and venous drip *chambers* allowing connections to *electronic pressure transducers*. In general, *electronic pressure transducers* convert pressure into voltage. Changes in pressure induce linear voltage changes between 0 and 10 vdc. The arterial transducer is located inside the *arterial blood pump module*. The venous transducer is located inside the *level detector module*.

### ARTERIAL PRESSURE

Pre-dialyzer BLOOD CIRCUIT pressure is monitored by the *arterial pressure transducer* ( $P_{ART}$ ). The arterial drip chamber may be located before the blood pump (pre-pump) or after the blood pump (post-pump) depending upon physician preferences.

### PRE-PUMP ARTERIAL PRESSURE MONITORING

The arterial transducer monitors pressure created by the blood pump *drawing* blood from the patient's vascular access. Because of this, pressure is negative (less than 0 mmHg). At atmospheric pressure arterial transducer voltage is calibrated to about +5 vdc. Increasing negative pressure induces linear voltage changes towards 0 vdc. Diagram 2.5 shows pre-pump arterial monitoring.

### POST-PUMP ARTERIAL PRESSURE MONITORING

The arterial transducer monitors pressure created by the blood pump *pushing* blood through the BLOOD CIRCUIT. Because of this, pressure is positive (greater than 0 mmHg). At atmospheric pressure, arterial transducer voltage is calibrated to about +2 vdc. Increasing positive pressure induces linear voltage changes towards +10 vdc. Diagram 2.6 shows post-pump arterial monitoring

### VENOUS PRESSURE

Post-dialyzer BLOOD CIRCUIT pressure is monitored by the *venous pressure transducer* ( $P_{ven}$ ) which monitors the pressure created by the blood pump *pushing* blood back into the vascular access. At atmospheric pressure, venous transducer voltage is calibrated to about +2 vdc. Increasing venous pressure induce linear voltage changes towards +10 vdc.

DIAGRAM 2.5 BLOOD AND DIALYSATE CIRCUITS, PRE-PUMP ARTERIAL MONITORING

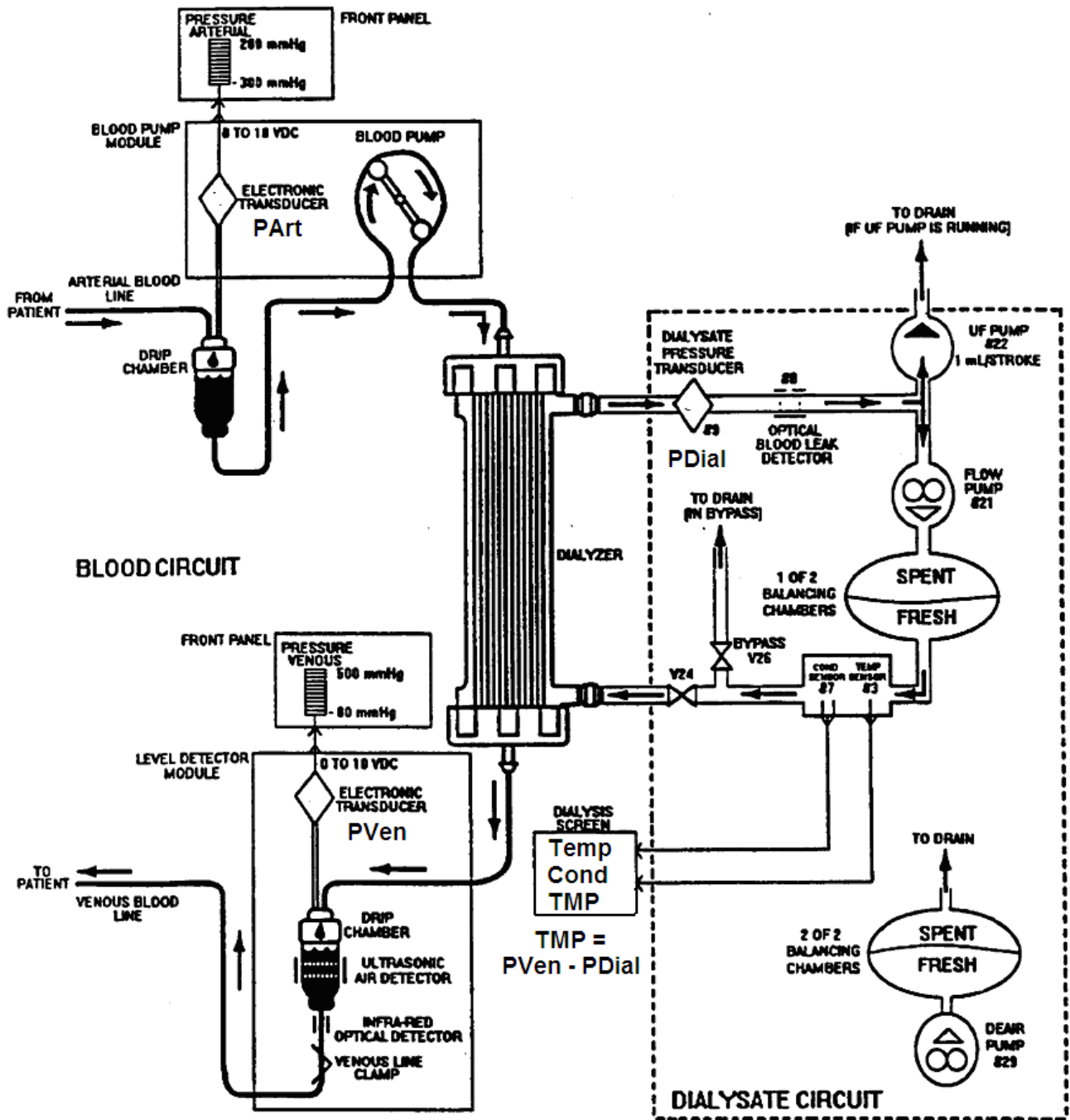
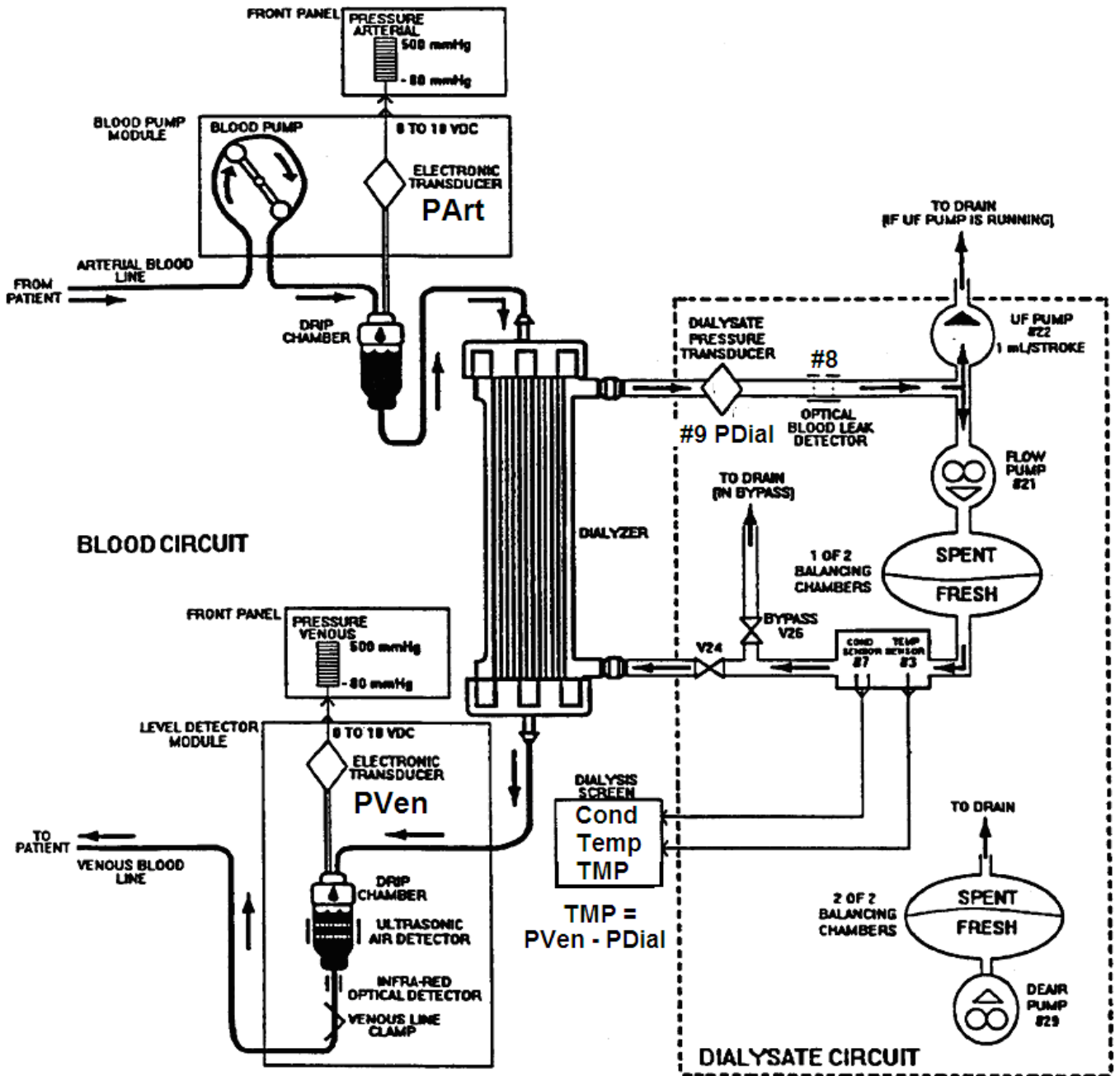

DIAGRAM 2.6 BLOOD AND DIALYSATE CIRCUITS, POST-PUMP ARTERIAL MONITORING



### ARTERIAL AND VENOUS PRESSURE DISPLAYS

$P_{ART}$  and  $P_{VEN}$  transducer voltage values are monitored by the sensor board which provides them to the function board. The function board provides both transducer voltage values to the front panel *bar graph* displays. The bar graphs indicate pressure in mmHg. During arterial and venous pressure calibrations voltage reference values are set and stored in function board RAM (random access memory) using a pressure standard. In operation the function board uses these reference values to determine which LED to light in the bar graph.

### PRE-PUMP ARTERIAL BAR GRAPH

Since pressure will be negative the front panel bar graph scale is chosen to monitor from - 300 to +280 mmHg.

### POST-PUMP ARTERIAL BAR GRAPH

Since pressure will be positive the front panel bar graph scale is chosen to monitor from - 80 to +500 mmHg.

### VENOUS BAR GRAPH

Since pressure will be positive the front panel bar graph scale is chosen to monitor from - 80 to +500 mmHg.

### ARTERIAL AND VENOUS PRESSURE ALARMS

*Actual* pressure values are monitored by the  $P_{ART}$  and  $P_{VEN}$  transducers. Independent upper and lower *limit* values are set and maintained by the function board's software. If an *actual* pressure value violates a *limit* value the function board issues a BLOOD ALARM which stops the blood pump and closes the venous line clamp as well as issues audio and visual signals to alert clinical staff.

### REDUNDANT MONITORING

$P_{ART}$  and  $P_{VEN}$  transducer voltages are redundantly monitored by the actuator board which also maintains backup alarm limits in the event of function board limit failures. The presence of function (soft) and actuator (hard) limits are tested during the ALARMS TEST.

### OPTICAL DETECTOR (OD)

The OD consists of an infra-red transmitter and a receiver. It is located directly below the venous line clamp on the level detector module (see Diagram 2.8). The venous blood tubing is threaded through the OD so that it is between the transmitter and receiver. When blood is flowing through the venous tubing the transmitted light is blocked causing the OD to send a 'blood sensed' signal to the function board. When blood is sensed:

- The lower venous alarm limit will not go below 0 mmHg
- Test and Prime is not allowed
- Audible alarms are enabled
- BVP (Blood Volume Processed) begins to measure the volume of blood delivered by the blood pump. BVP is seen on the main dialysis screen.
- Arterial, venous and TMP alarm limits center themselves around the current '*actual*' pressure values.

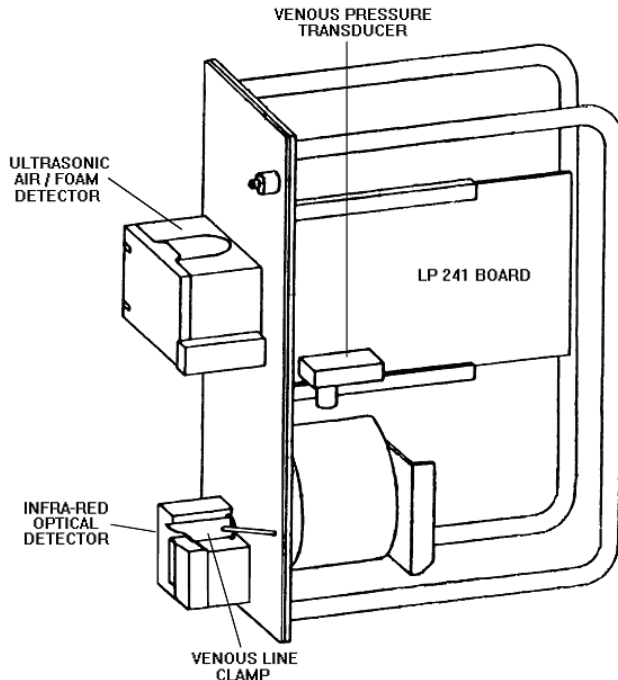

**DIAGRAM 2.8 LEVEL DETECTOR MODULE**

**3. CONTROLS 'DIALYSATE CIRCUIT' FLOW**

The DIALYSATE CIRCUIT (see Diagram 2.5) consists of two separate *balancing chambers* and three pumps *flow pump #21*, *deaeration pump #20* and *UF pump #22*.

- a) The BALANCING CHAMBERS consist of two cylindrical chambers, each with a volume of 30 (+/- 1) ml. A flexible, non-permeable, diaphragm divides each chamber into a FRESH (pre-dialyzer) and SPENT (post-dialyzer) dialysate compartment. The diaphragm's flexibility and non-permeability allows varying amounts of FRESH and SPENT dialysate to be in the chambers while keeping the FRESH and SPENT compartments isolated from each other at all times. The BALANCING CHAMBERS cycle such that one is connected to the dialyzer while the other is connected to the drain.
- b) Flow pump #21 fills one of the BALANCING CHAMBERS with SPENT dialysate which, in turn, forces 30 ml of FRESH towards the dialyzer. Simultaneously deaeration pump #20 fills the other BALANCING CHAMBER with FRESH dialysate forcing 30 ml of SPENT to the drain. When the flow pump has filled its chamber completely, the BALANCING CHAMBERS cycle and the sequence repeats itself. This results in a continuous flow of FRESH to the dialyzer and SPENT to the drain.
- c) Flow pump speed depends on the currently selected flow rate. It MUST fill the chambers in a given amount of time to maintain the selected flow rate. Actuator and function board circuitry assures that the flow pump fills the chamber as required (discussed later). For example, if the current flow rate is selected at 500 ml/min the flow pump MUST fill the chamber in 3.6 seconds ( $30 \text{ ml} / 3.6 \text{ sec} = 500 \text{ ml/min}$ ).



4. REMOVES WATER (ULTRAFILTRATE) FROM THE PATIENT'S BLOOD

- a) UF PUMP #22 has access to the DIALYSATE CIRCUIT. When running, it removes volume in 1 ml increments sending it directly to the drain. Any volume removed creates pressure in the DIALYSATE CIRCUIT which is monitored by the *dialysate pressure transducer #9*.
- b) When a dialyzer is connected any volume removed is replaced through the dialyzer by causing water (ultrafiltrate) to move from the blood side, through the dialyzer membrane, into the DIALYSATE CIRCUIT. The pressure created on the membrane to make this happen is called *transmembrane pressure (TMP)*.

TRANSMEMBRANE PRESSURE (TMP)

TMP is a function of pressures on the blood and dialysate side of the dialyzer membrane. Blood side pressure is monitored by the venous pressure transducer ( $P_{VEN}$ ). Dialysate side pressure ( $P_{DIAL}$ ) is monitored by the dialysate pressure transducer #9. TMP can be mathematically expressed using both pressure components:

$$TMP = P_{VEN} - P_{DIAL} \quad \text{Equation 2.0}$$

**NOTE:** Dialysate pressure can have a positive or negative value depending on the volume needs of the DIALYSATE CIRCUIT.

UF RATE (UFR)

The rate at which the UF pump #22 runs (UFR) is set by clinical staff and is determined by how much weight the patient has gained since their last dialysis treatment. This is done by subtracting the patient's *dry weight* from the *pre-dialysis weight* and dividing the result by the *dialysis time*.

$$UFR \text{ (ml/Hr)} = [*Pre-Weight - Dry Weight] \div \text{Dialysis Time} \quad \text{Equation 2.1}$$

\* Pre-Weight includes any saline given before or during the treatment.

- DRY-WEIGHT is the patient's ideal body weight. It is medically determined based on physical factors such as age, sex, diet, etc. Ideally, this will be the patient's post-dialysis weight.
- PRE-WEIGHT is what the patient weighs pre-dialysis.
- DIALYSIS TIME is medically determined amount of time that the patient should be dialyzed.

## Section II – Hemodialysis Review

### FLUID REMOVAL COEFFICIENT (KUF)

The amount of TMP created, at a given UFR, is solely a function of the dialyzer's permeability to water. Dialyzer permeability is defined by a value known as KUF. KUF values are determined, by the dialyzer's manufacturer, in vitro. It is *the amount of water removed (in ml) per hour per each mmHg of TMP*.

$$\text{KUF} = \text{ml/Hr/TMP (mmHg)} \quad \text{Equation 2.2}$$

Since  $\text{UFR} = \text{ml/Hr}$  then Equation 2.2 can be expressed as:

$$\text{KUF} = \text{UFR/TMP} = \text{UFR} \div \text{TMP} \quad \text{Equation 2.3}$$

or

$$\text{UFR} = \text{KUF} \times \text{TMP} \quad \text{Equation 2.4}$$

or

$$\text{TMP} = \text{UFR/KUF} = \text{UFR} \div \text{KUF} \quad \text{Equation 2.5}$$

### HELPFUL CONVERSION FACTORS

$$1 \text{ Kg} = 1 \text{ Liter} = 1000 \text{ ml} = 2.2 \text{ lbs}$$

#### **EXAMPLE 1.0**

A male patient comes in for dialysis weighing 57 Kg. His dry weight is 53 Kg. He receives no saline and will dialyze for 4 hours on a dialyzer that has a KUF of 5 ml/Hr/mmHg. His  $P_{\text{VEN}}$  is 160 mmHg. Determine:

- 1) What is his pre-dialysis weight in pounds?
- 2) How much weight in Kg must be removed during the treatment?
- 3) What UFR is required to accomplish this?
- 4) What will the TMP be?
- 5) What will the dialysate pressure be ( $P_{\text{DIAL}}$ )?

#### **ANSWERS:**

- 1)  $57 \text{ Kg} \times 2.2 \text{ lbs/1 Kg} = \underline{125.4 \text{ lbs}}$
- 2)  $\text{PW} - \text{DW} = (57 - 53) \text{ Kg} = \underline{4 \text{ Kg}}$
- 3)  $\text{UFR} = \text{PW} - \text{DW} \div \text{DT} = (57 - 53)\text{Kg} \div 4 \text{ Hr} = 1 \text{ Kg/Hr} = \underline{1000 \text{ ml/Hr}}$
- 4)  $\text{TMP} = \text{UFR} \div \text{KUF} = 1000 \div 5 = \underline{200 \text{ mmHg}}$
- 5) Rearranging Equation 2.0,  $P_{\text{DIAL}} = P_{\text{VEN}} - \text{TMP}$  **Equation 2.6**  
 $P_{\text{DIAL}} = P_{\text{VEN}} - \text{TMP} = 160 - 200 = \underline{-40 \text{ mmHg}}$

**EXAMPLE 1.1**

If the dialyzer, from example 1.0, was changed to one that has a KUF of 50 calculate the; 1) TMP; 2) Dialysate Pressure

**ANSWERS:**

- 1)  $TMP = UFR \div KUF = 1000 \div 50 = \underline{20 \text{ mmHg}}$
- 2)  $P_{DIAL} = P_{VEN} - TMP = 160 - 20 = \underline{+140 \text{ mmHg}}$

**SECTION 1 HOMEWORK PROBLEMS**

- 1) A patient is on a dialyzer with a KUF of 25. The TMP is 100 mmHg. What is the UFR? \_\_\_\_\_ ml/hr. How much fluid will this patient lose in 3 hours? \_\_\_\_\_ ml
- 2) A patient is on a dialyzer that has a KUF of 5. UFR is 1500 ml/hour. What is the TMP? \_\_\_\_\_ mmHg. If the patient's venous pressure is 200 mmHg what is the dialysate pressure? \_\_\_\_\_ mmHg
- 3) A patient is on a dialyzer with a KUF of 50. The UFR is 2500 ml/hour. What is the TMP = \_\_\_\_\_ mmHg. If the patient's venous pressure is 200 mmHg what is the dialysate pressure? \_\_\_\_\_ mmHg
- 4) A male patient is on a dialyzer with a KUF of 10. The TMP is 100 mmHg. His dialysis time is 3 hours and he is 4 liters over dry weight. Will he reach his goal in this time?
- 5) A patient must lose 5 liters in 2.5 hours. The machine stabilizes at a TMP of 400 mmHg. What is the KUF of the dialyzer? \_\_\_\_\_ ml/hr./mmHg
- 6) A patient is 6.6 lbs over dry weight. Dialysis time is 3 hours. What will the UFR be? \_\_\_\_\_ ml/Hr
- 7) A 70 year old female patient is on a dialyzer that has a KUF of 60. Her dry weight is 90 lbs (41 liters). Her DT is = 4 hours. PW = 45.8 liters.  $P_{VEN} = 180 \text{ mmHg}$ . What is the UFR? \_\_\_\_\_ ml/hr. What is the TMP? \_\_\_\_\_ mmHg
- 8) Because of a hydraulic leak the  $P_{DIAL}$  (from problem #7) decreases by 20 mmHg. What is the UFR caused by the leak? \_\_\_\_\_ ml/hr. What may happen to this patient if the problem is allowed to continue?



**SECTION III**

**HYDRAULIC DESCRIPTION**



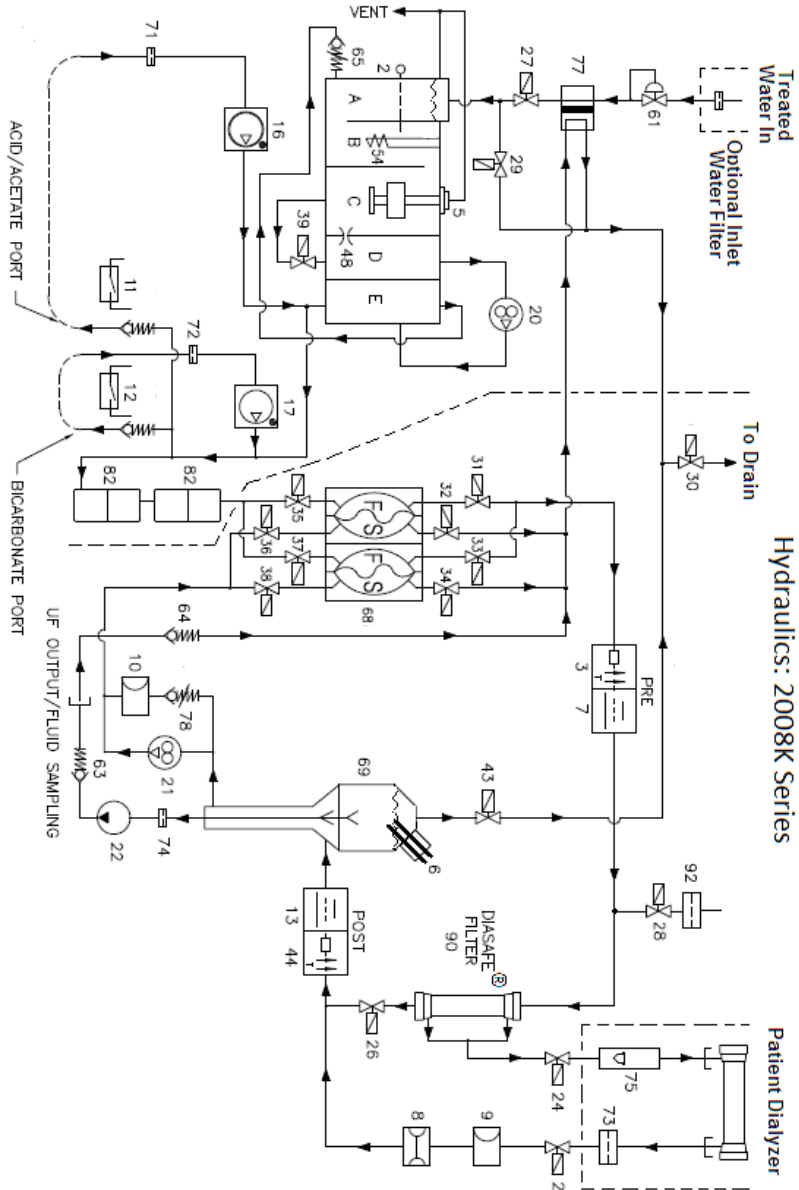

Hydraulics: 2008K Series

LEGEND:

- 1 NT-C#2 Temperature Control Sensor [CON-NTC]
- 2 NT-C#3 Temperature Monitor Sensor [MON-NTC]
- 3 Float Switch [FLOAT-SW]
- 4 Air In Switch Sensor [AIR-SEN]
- 5 Pre-Dialyzer Conductivity Sensor [COND]
- 6 Blood Leak Sensor [BLOOD LEAK]
- 7 Dialyzer Pressure Sensor [P-DIAL]
- 8 Chamber Full Switch Sensor [CF-S]
- 9 Acid Connector Read Switch [CONC-SW]
- 10 Bicarbonate Connector Read Switch [BIC-SW]
- 11 Post-Dialyzer Conductivity Sensor [NTC-POST]
- 12 Acid (Concentrate) Pump [CONC-P]
- 13 Bicarbonate Pump [BIC-P]
- 14 Desaturation Pump [DE-GAS-P]
- 15 Flow Pump [FLOW-P]
- 16 Ultrafiltration (UF) Pump [UF-P]
- 17 To Dialyzer Valve (Arve #1) [DIAL-V1]
- 18 From Dialyzer Valve [DIAL-V2]
- 19 Bypass Valve [BYPAS-V]
- 20 Inlet Water Valve [IN-V]
- 21 Recirculation Valve [REC-V]
- 22 Drain Valve [DRAIN-V]
- 23 - 38 Balancing Chamber Valves [V31 - V38]
- 39 Vacuum Relief Valve [DE-AR-V]
- 40 Vent Valve for Chamber #69 [V43]
- 41 Post-Dialyzer Conductivity Sensor [NTC-POST]
- 42 Desaturation Restrictor
- 43 Heater Element (120 V AC)
- 44 Inlet Water Pressure Regulator (18 - 20 psi)
- 45 Check Valve (15 psi) UF Pump to UF Sample Port
- 46 Check Valve (2 psi) UF Pump to Drain
- 47 Loading Pressure Valve
- 48 Balancing Chambers
- 49 Air Separation Chamber
- 50 Acid Connector Filter (inside red connector)
- 51 Bicarbonate Connector Filter (inside blue connector)
- 52 External Dialyzer Filter
- 53 Pre-UF Pump Filter
- 54 Heat Exchanger
- 55 Flow Pump Relief Valve (35 - 36 psi with DiSaSg, 29 - 30 w/o)
- 56 Fresh Dialyzer Mixing Chambers
- 57 DiSaSg Filter
- 58 Filter for Valve #28

**NOTES**

---

---

---

---

---

---

---

---

---

---

---

---

---

---

---

---

---

---

---

---

---

---

---

---

---

---

---

---

---

---





### *Section III – Hydraulic Description*

#### **Inlet Water Filter (optional; not shown)**

If present, this filter is typically located in the inlet water connector.

#### **Inlet Water Regulator #61**

Manually calibrated to approximately 20 psi when incoming water valve #41 is closed. This regulator protects incoming water valve #41 from excessive incoming water pressure.

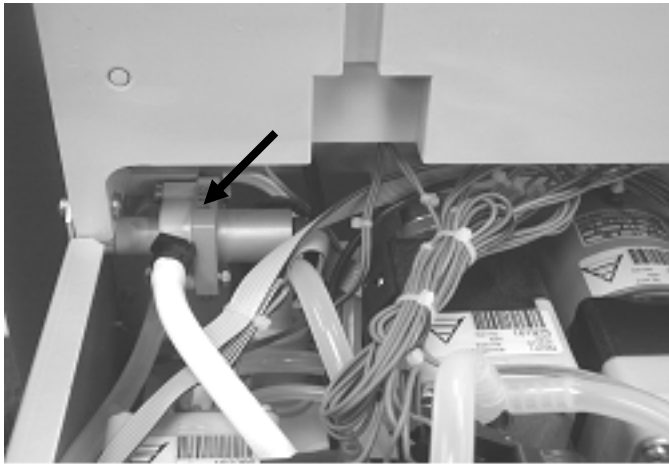

#### **Heat Exchanger #77**

Consists of two compartments ('incoming water' and 'spent') separated by a thin metallic (heat conducting) plate. The heated 'spent' fluid, on its way to the drain passes through the exchanger and warms the plate which warms the incoming water as it is passing through.

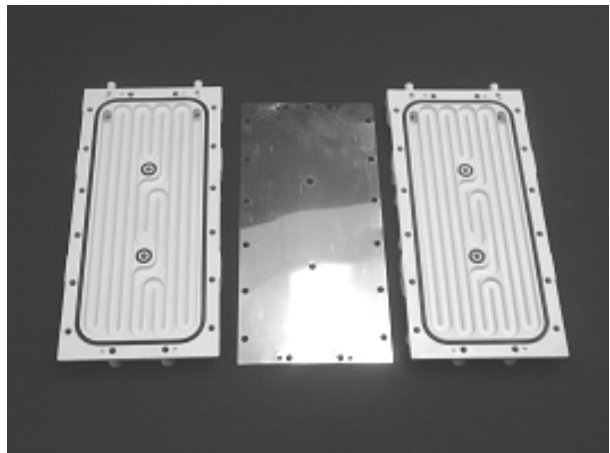
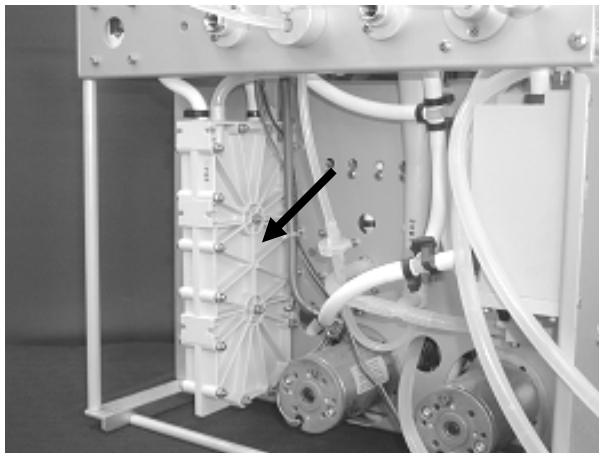

**Valve #41(27)** (incoming water valve): Opens when the float bob (#5, in hydro chamber C) drops; Closes when the float bob rises.

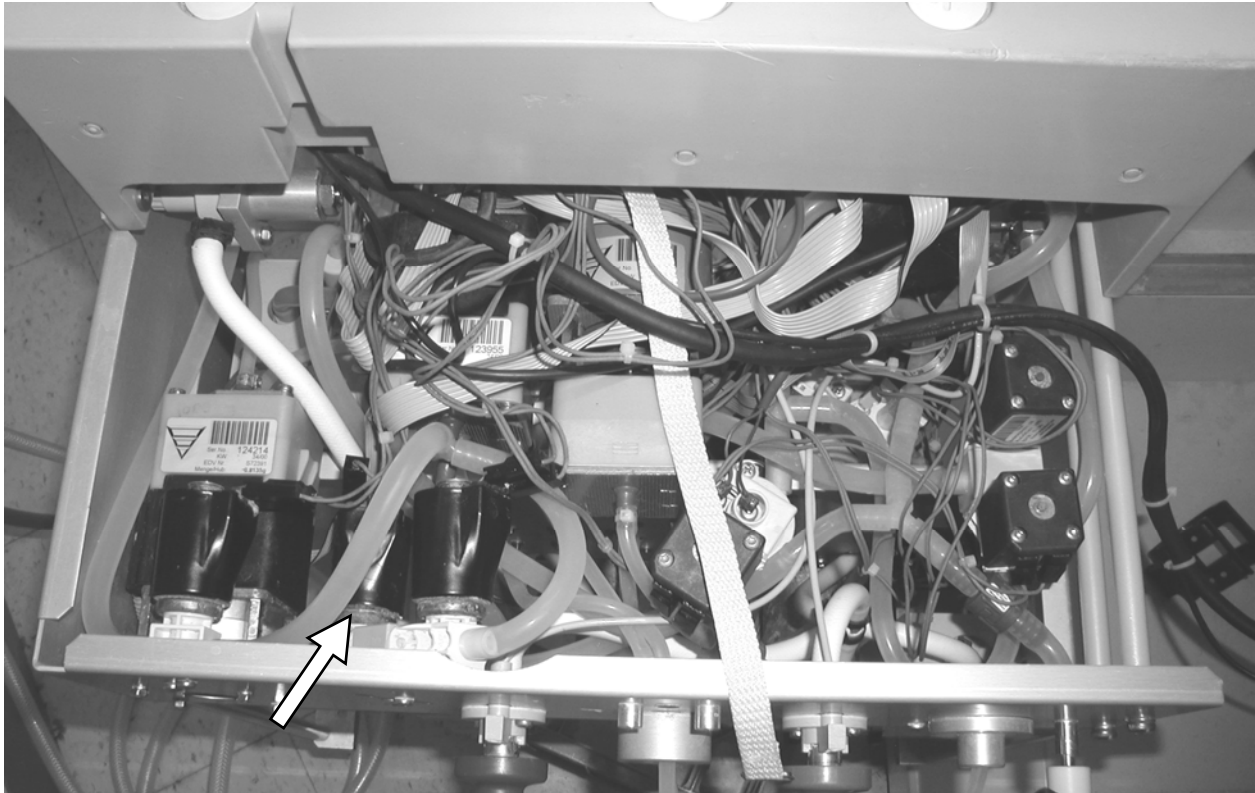

➤ **Solenoid Valves**

Solenoid valves are electronically controlled by the Actuator board. When a solenoid ‘energizes’ (with +24 volts DC) the induced magnetic field quickly opens the valve plunger and allows flow through the valve. When the solenoid is de-energized (0 Volts DC) the plunger is mechanically closed by a spring and flow is stopped.

- All electronically controlled valves are ‘normally closed’; energized open with 24 volts DC from the Actuator board.
- Solenoid resistance is approximately 60 ohms.

### Section III – Hydraulic Description

**Hydro block/Hydrochamber** (five chambers, A, B, C, D, E):

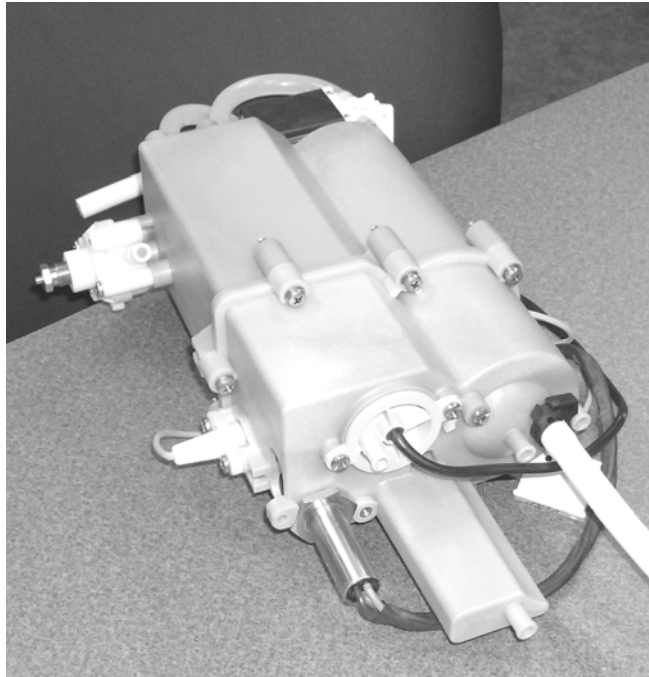

**Chamber A (inlet water chamber):** When valve #41 opens, as controlled by the float #5, water enters the machine and flows into Chamber A through a vented air gap. The air gap and vent provides ‘back flow’ protection.

**Chamber B (heater chamber):** This chamber houses heater #54 and temperature control sensor NTC #2.

- **Heater Element #54:** 1300 Watt, 120 Volt AC element with an internal resistance of approximately 11 ohms. Voltage is switched to the heater by a triac (located in the power supply).
- **NTC #2 (Heater Control Sensor):** Measures temperature and controls the heater element #54 via the triac. If measured temperature is less than set point temperature the heater is turned on.
  - **Temperature Control:** NTC#2 is monitored by the Sensor board. When chamber B temperature falls below the set point temperature the Sensor board turns on a ‘triac’ which switches 120 volts AC to the heater element. The triac is located in the power supply.

**Chamber C (float chamber):** Houses the float (#5) that controls the water level in the hydro block. It consists of a bob that moves vertically, up and down, on a shaft. A magnet is embedded in the bob and a Hall Effect (reed) switch is embedded near the bottom of the shaft. As the water level decreases the bob drops until it reaches the reed switch. This signal (monitored by the Sensor board) informs the Actuator board to open valve #41(27).

**Chamber D (deaeration chamber):** Provides input to deaeration pump #20.

**Restrictor Orifice #48:** Restricts inlet flow to the deaeration pump #20 in Dialysis Program.

**Deaeration Pump #20:** A strong gear-type pump magnetically coupled to a DC motor controlled by the Actuator board. When valve #39 is closed (in Dialysis Program) the Deaeration pump is forced to draw fluid through restrictor orifice (#48). This creates a large vacuum (calibrated target value: -24inHg) that expands dissolved gasses.

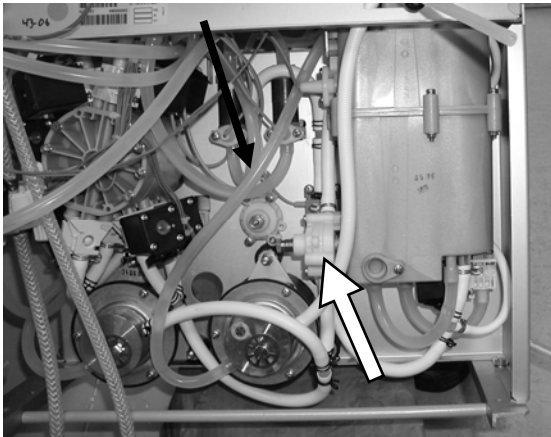

**Loading Pressure Valve #65:** Located at the bottom side of chamber A this valve is manually calibrated to open when the deaeration pump's #20 output pressure reaches approximately 24 - 25 psi.

**Chamber E (air removal chamber):** Deaeration pump #20 re-circulates air and water into chamber E where air separates and rises to the top via gravity. When chamber E pressure reaches the manually calibrated set point of valve #65 it opens and allows air/water re-circulation back to chamber A. Air is released to atmosphere via the vent tube.

### Section III – Hydraulic Description

**Conc (acid) Pump #16 and Bicarbonate Pump #17:** These are piston-diaphragm pumps that must draw and deliver precise volumes to accurately control dialysate electrolytic profiles.

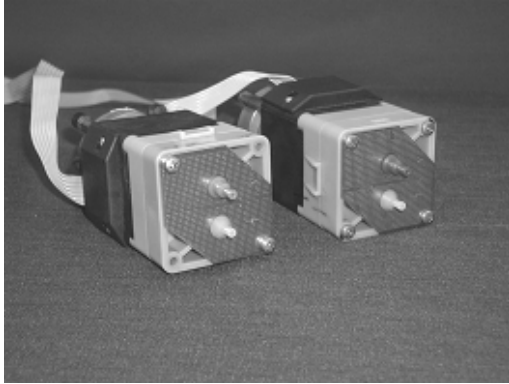

- Inside each pump a soft diaphragm that is attached to one end of a piston. When the piston mechanically moves backwards the diaphragm's surface is displaced creating suction. The volume drawn depends on how far the piston moves backwards. Delivery occurs when the piston changes direction and moves forward pushing the diaphragm which pushes the concentrate out of the pump.
  - The pistons are mechanically propelled by *stepper motors* coupled to the pistons with a rotating screw gear.
  - Stepper motors can be precisely started and stopped and provide precise volume control. The motors used by Fresenius Medical Care rotate 1.8 degrees/step (i.e. 200 steps = 360 degrees). Because rotation is controlled by steps, to increase or decrease volume the Actuator board increases or decreases the number of steps sent to the motor (i.e. more steps = more volume).
  - **End Of Stroke (EOS):** Each concentrate pump uses optical EOS sensors that serve to locate the pumping-piston's mechanical location inside the pump housing. During machine power on the Actuator board steps each motor to move the pistons back to their mechanical EOS (home) location.
  - As the pumps draw, the piston mechanically moves away from EOS by a \*required number of motor steps. When delivering the motor steps the piston back until it again reaches the EOS location. If the number of steps it takes to reach EOS is the same as the 'required' number of steps the machine knows that the pump is mechanically operating properly and is delivering the proper volume.
- \* The Actuator board determines how many steps are 'required' to properly proportion the dialysate to the correct electrolytic levels.

**Acid Filter #71 and Bicarbonate Filter #72:** Located inside the red and blue concentrate connectors. They prevent dirt from being drawn into the pump that may damage internal soft parts.



**Mixing Chambers #82:** The acid and bicarbonate concentrates are injected into the loading pressure water stream, post hydro-block and then stirred by the mixing chambers. This is the final step of dialysate preparation before the Balancing Chambers.

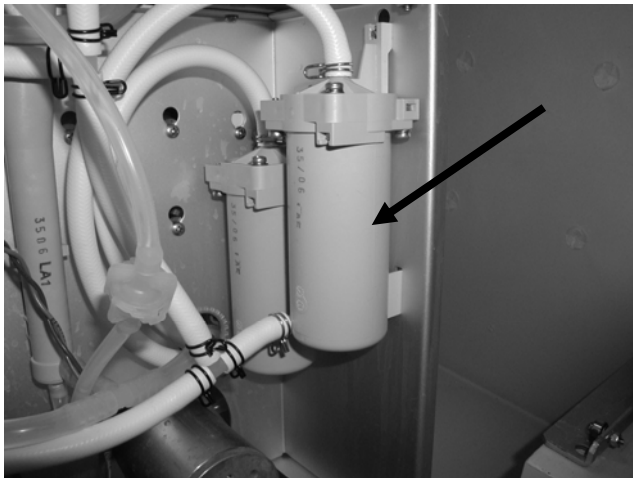

*Section III – Hydraulic Description*

**Switch #11:** Hall affect (reed) switch located at the acid rinse port. The red concentrate connector has an embedded magnet. When the connector is plugged into its port the reed switch closes. This signal is monitored by the Sensor board then provided to the Actuator and Functional boards, and along with Reed switch #12 allows or disallows Dialysis/Rinse programs.

**Switch #12:** Hall affect (reed) switch located at the bicarbonate rinse port that closes when the blue connector is plugged into its port. This signal is monitored by the Sensor board then provided to the Actuator and Functional boards, and along with Reed switch #11 allows or disallows Dialysis/Rinse programs.

Red Connector	Blue Connector	Program(s) Allowed
OUT	OUT	Dialysis
OUT	IN	Dialysis
IN	OUT	None
IN	IN	Cleaning

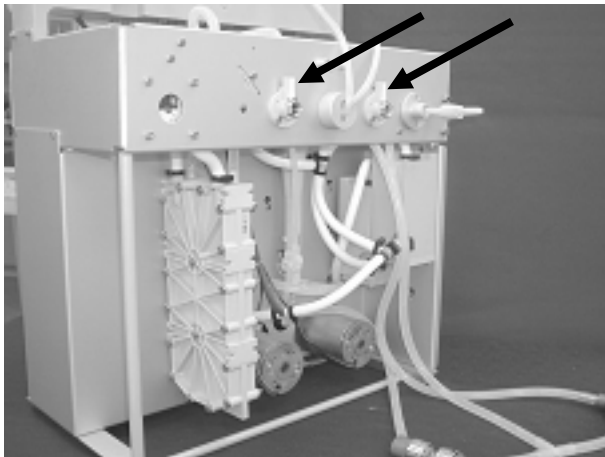



**Balancing Chambers #68:** The balancing chambers consist of two cylindrical 30 ml (approximately) chambers. Each chamber contains a non-permeable, flexible diaphragm that provides complete isolation between fresh ('F', pre-dialyzer) and spent ('S' post-dialyzer) fluid. Flow through the balancing chambers is controlled by a set of eight solenoid valves (valves #31 through #38) that open and close in a two-part sequence called Valve Cycle 1 and Valve Cycle 2. Under the influence of the deaeration pump #20 and flow pump #21 the diaphragms move back and forth to either the extreme right or left side wall of the chamber (see explanation below, referring to the Hydraulic Flow Diagram):

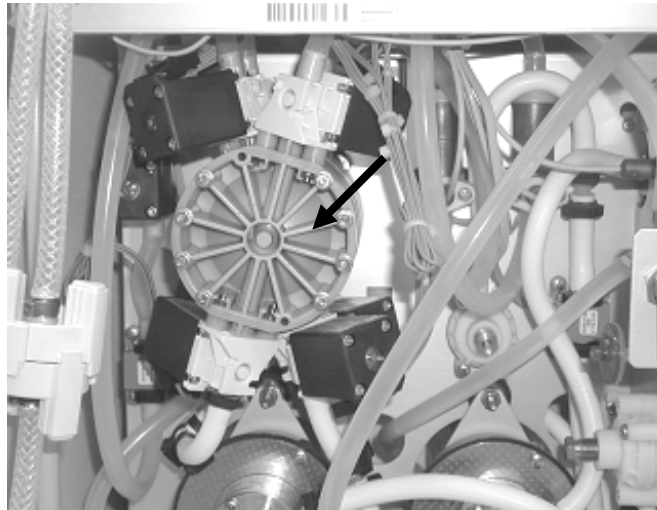

- **Valve Cycle 1:** Valves # 35, 38, 32 and 33 open; Valves # 36, 37, 31, 34 closed. Deaeration pump #20 fills the left side Balancing Chamber with 'fresh' forcing the diaphragm towards the right wall displacing spent to the drain (via the heat exchanger and valve #30); Flow Pump #21 fills the right side Balancing Chamber with spent forcing the diaphragm towards the left wall displacing fresh towards the dialyzer.
- **Valve Cycle 2:** Valves # 35, 38, 32 and 33 closed; Valves # 36, 37, 31, and 34 open. Deaeration pump #20 fills the right side Balancing Chamber with 'fresh' forcing the diaphragm towards the right wall which displaces spent to the drain; Flow Pump #21 fills the left side Balancing Chamber with spent forcing the diaphragm towards the left wall displacing fresh towards the dialyzer.
- **Balancing Chamber Valve Dead Time:** When switching from one balancing chamber valve cycle into the next 50 milliseconds is allowed before energizing (opening) the alternate set of four. This allows the four open valves to close fully before the alternate set of four are opened. This process aids Ultrafiltration (UF) accuracy.

### Section III – Hydraulic Description

**Conductivity Cell #7 (pre-dialyzer):** Consists of two internal probes that are provided with a small AC current from the Sensor board. The electrolytic content of the fluid flowing through the cell affects the AC resistance path between the probes which in turn varies AC frequency. Frequency is converted to standard conductivity units (mS/cm) which is displayed digitally to the front panel.

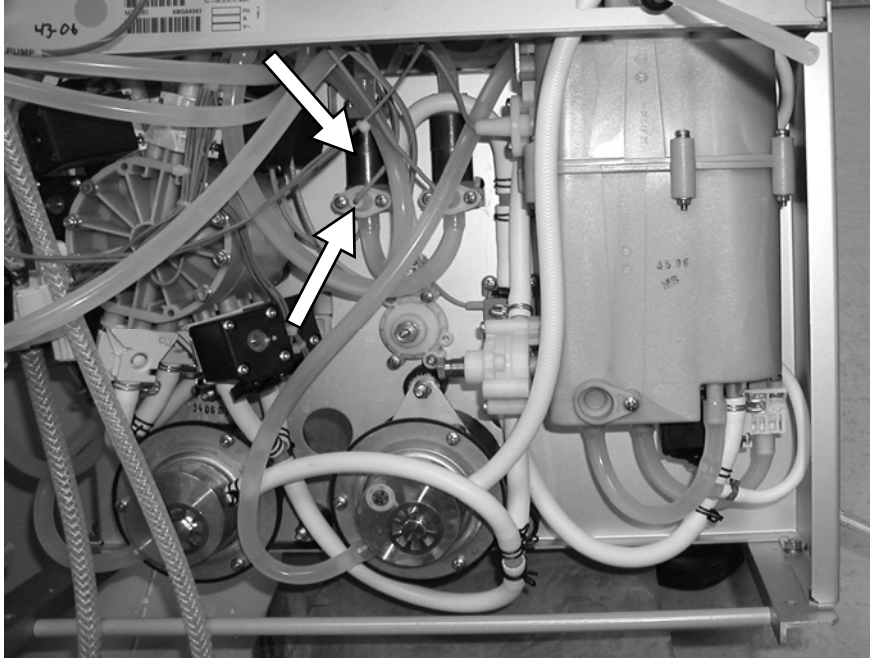

**NTC #3 (Temperature Monitor Sensor, pre-dialyzer):** Located next to conductivity cell #7, this device has the same characteristics as NTC #2 (discussed earlier). It is part of a voltage divider located on the Sensor board. Changes in temperature (i.e. changes in voltage) are converted to standard temperature units (degrees Celsius) and then displayed digitally to the front panel. NTC#3 values are also used to compensate displayed conductivity readings from Conductivity Cell #7.

- **Heater Runaway Protection:** In the event of a heater control runaway when temperature increases to 41 degrees Celsius (way beyond the target value) the ‘heater safety relay’ (located in the power supply) switches off. This disconnects the heater circuit from its AC source. This feature prevents damage to the hydro block due to high temperature.

**Diasafe® Filter Test Valve (depends on how the machine is equipped):**

- **Valve #91:** A three-way ‘manually set’ valve used in conjunction with the UF Pump #22 to pressure test the Diasafe® filter. Normally (the ‘DIALYZE’ position) the bottom-to-common port is open and flow is allowed from the balancing chambers into the dialyzer circuit. When a Diasafe® filter test is desired valve #91 is manually switched into the ‘TEST’ position. This causes the top-to-common port to open. Also dialysate flow is turned off, and the **UF Pump** is turned on, drawing air through filter #92 into the Diasafe® filter.
- **Valve #28:** A two-way electronically controlled solenoid valve. It serves the same purpose as valve #91 (above) in that it is used to pressure test the Diasafe® plus filter by allowing air into Diasafe® plus filter through filter #92. If the machine is equipped with solenoid valve #28 the leak test is automated.

**Diasafe Filter #90:** Removes pyrogenic and bacterial material prior to entering the dialyzer.

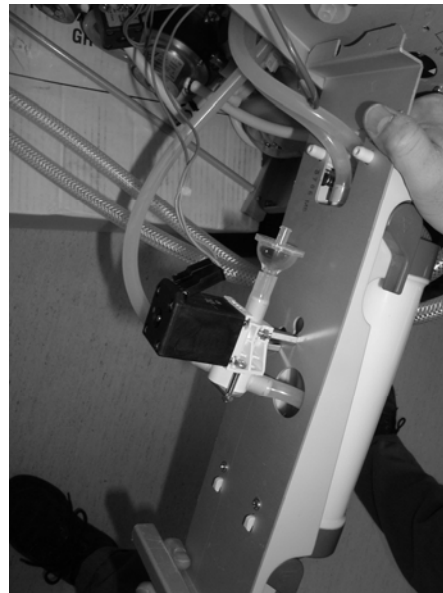

### Section III – Hydraulic Description

**Valve #24 (Dialyzer valve):** Open if conductivity and temperature readings (from conductivity cell #7 and NTC #3) are within limits; closed otherwise in conjunction with valve #26 opening.



**Valve #26 (Bypass valve):** Closed if conductivity and temperature readings are within limits; open otherwise in conjunction with valve #24 closing.

- **Shunt Door Interlock Switches:** Three micro-switches (located under the shunt door) that sense the position of dialyzer Hansen connectors (in the shunt or not) and the shunt door (open/closed).

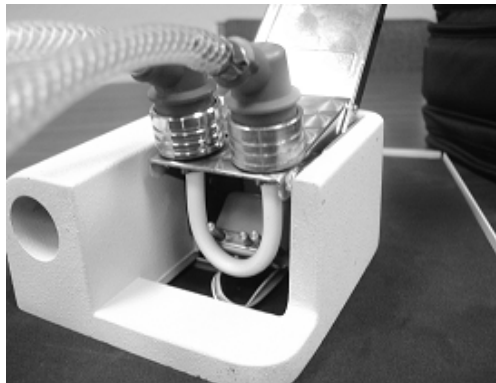

- If the shunt door is open ‘bypass’ occurs (i.e. valve #24 closes, #26 opens) and also valve #25 closes.
- Both dialyzer Hansen connectors must be in the shunt door and the door closed to enter a Cleaning Program.
- If the blue Hansen is in the door and the red Hansen is left on the dialyzer and the shunt door is closed the machine enters “Emptying Program”. A special Balancing Chamber sequence (Valves #31, 33, 35, and 37 close; Valves #32, 34, 36 and 38 open) occurs. Valve #25 remains open and flow pump #21 runs to draw dialysate out of the dialyzer sending it to the drain. This feature can be useful lessen the weight of medical waste since now an *empty* dialyzer is discarded.

**External Flow Indicator #75:** A glass tube with a float ‘bob’ inside. When the machine is ‘out of bypass’ (i.e. valve #24 open, #26 closed), dialysate enters the dialyzer which causes the ‘bob’ to rise and fall. When ‘bypass’ occurs (due to a Conductivity or Temperature alarm) valve #24 closes and valve #26 opens and the ‘bob’ stops moving up.



**External Filter #73:** Prevents larger particles from re-entering the hydraulics via the dialyzer.

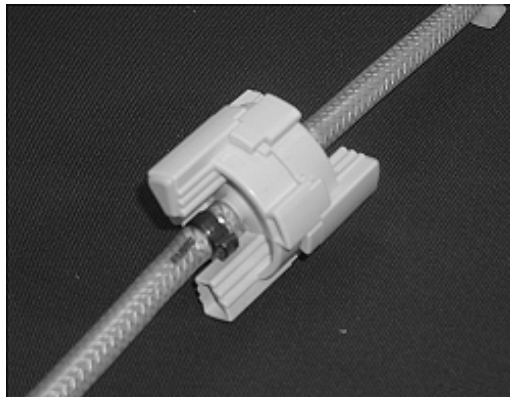

### Section III – Hydraulic Description

**Valve #25:** Solenoid valve that remains open unless the machine is performing ‘On Line Pressure Holding Test (PHT) or the shunt door is open or with certain TMP alarms.

- **On Line PHT:** If activated, performed every 12 minutes (720 seconds) to check for volumetric leaks. The machine goes into bypass (i.e. valve #24 closes, valve #26 opens) and valve #25 closes to ‘remove’ the dialyzer from the hydraulics. The dialysate pressure transducer #9 is read for two BC cycles checking for pressure stability.

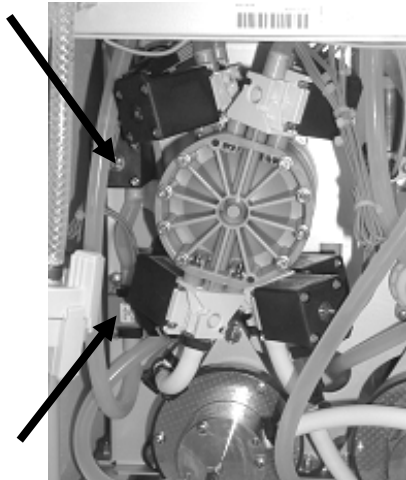

**Dialysate Pressure Transducer #9:** This strain gauge transducer senses pressure in the dialysate circuit ( $P_{DIAL}$ ). The Sensor Board provides its signal so that changes in pressure directionally affect its DC voltage output. This transducer can measure positive and negative dialysate pressure.  $P_{DIAL}$  voltage values are converted to standard pressure units (mmHg) and displayed to the front panel.

- Transmembrane Pressure (TMP) = Venous Pressure ( $P_{VEN}$ ) – Dialysate Pressure ( $P_{DIAL}$ )
- $TMP = P_{VEN} - P_{DIAL}$       **Equation 1**

**#8 Blood Leak Detector:** Optically monitors for Red Blood Cells (RBC) that may leak through the dialyzer membrane. An intact dialyzer will not allow RBC to escape. The detector consists of a red/green transmitter and two receivers (Blood Leak and Dimness). Receiver voltages are monitored by the Sensor board and will be approximately 4.99 volts DC with no RBC present (i.e. clear dialysate). If blood is sensed (as little as 0.35 ml/Liter) Dimness receiver voltage decreases and the machine issues a Blood Leak alarm.



**Post-Dialyzer Conductivity Cell #13:** Used by the machine's On Line Clearance (OLC) function, this cell VERY accurately monitors conductivity post dialyzer. It works in conjunction with pre-dialyzer Conductivity Cell #7 to determine a change in conductivity before and after the dialyzer. Sodium accounts for 85% of the total Conductivity and because the sodium and urea molecules are very near the same size urea clearance ( $Kt/V$ ) can be calculated by determining sodium clearance.

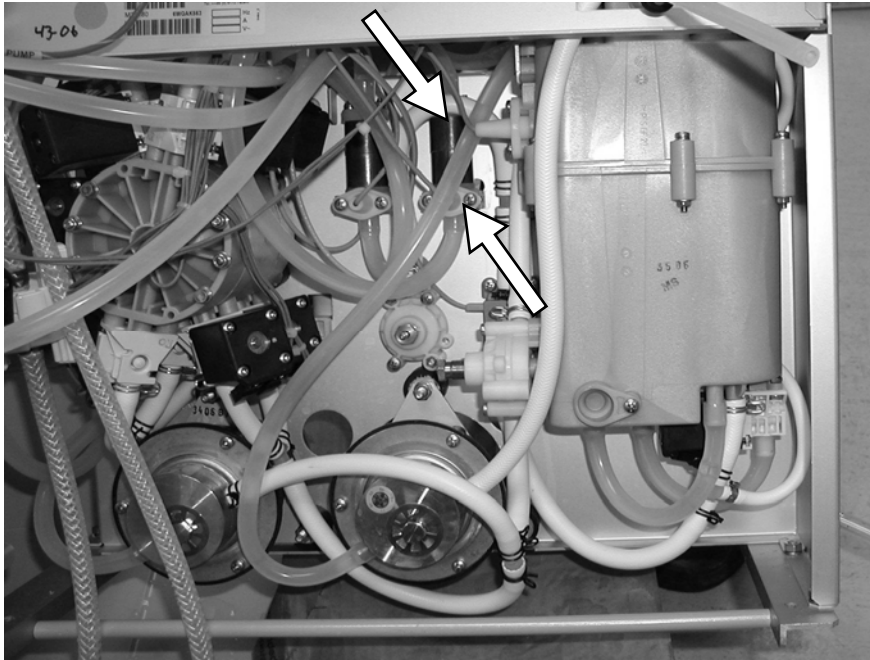

**Post-Dialyzer Temperature Monitor NTC #44:** This monitor (same operating characteristics as NTC #2 and #3) monitors temperature post dialyzer. Its only purpose is to compensate conductivity readings from Conductivity Cell #13.

**Valve #43:** Solenoid valve that opens during 'Filling Programs' and at various times in the Cleaning Programs to disinfect/rinse its flow path.

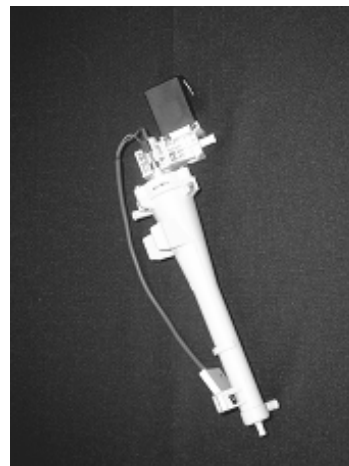
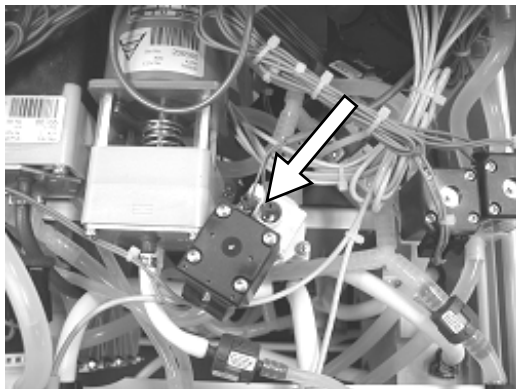

### Section III – Hydraulic Description

**Air Removal Chamber #69:** Captures and removes air in the fluid prior to entering the Balancing Chambers. Two probes extend into the chamber that is provided with a small AC current from the Sensor board. If the chamber remains full the probes remain submerged and, if the fluid is conductive, a current path exists between them. If air continually enters the chamber the fluid volume decreases until the current path is broken. In this event the Actuator board initiates a ‘Filling Program’. Valve #43 opens to purge air to the drain and a ‘special’ Balancing Chamber Valve sequence occurs.

- 10 Fill Programs: If the machine enters 10 Fill Programs in any 60 minute interval the machine responds with a “10 Fill Programs in One Hour” message. This typically means that a large air leak is present. FILL ALARM is a watchdog alarm that will occur after 5 (five) fill programs with blood sensed (patient connected).

**Flow Pump #21:** Like the deaeration pump, flow pump #21 is a gear-type pump that is magnetically coupled to a DC motor controlled by the Actuator board that precisely controls dialysate flow through the dialyzer.

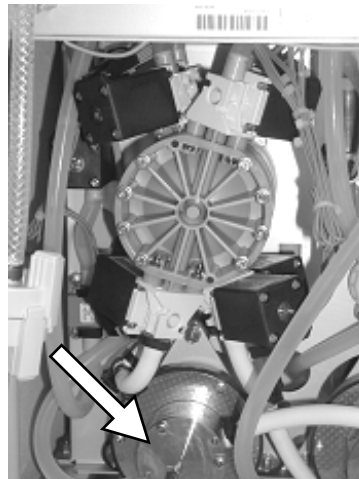

**CFS Pressure Transducer #10:** Strain gauge transducer (like dialysate pressure transducer #9) located at the output of the flow pump #21 and monitored by the Sensor board. As flow pump #21 fills a Balancing Chamber pressure here will be relatively low. When the balancing chamber becomes totally filled pressure increases drastically (due to the ‘dead head’) which notifies the Actuator board that it is time to switch the Balancing Chamber valves into the next cycle.

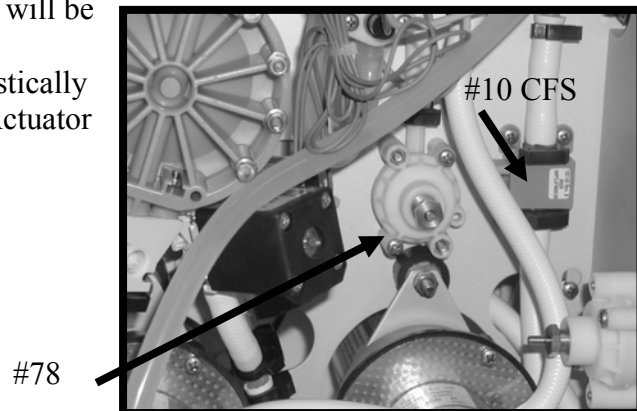



- Flow Rate = Flow Volume/Time                      **Equation 2.0**
- Required Balancing Chamber Switching Time (BC Switch) =  $1800 \div \text{Flow Volume}$   
**Equation 3.0**
- Flow Rate Example: If the selected dialysate flow rate is 500 ml/min; BC Switch =  $1800 \div 500 = 3.6$  seconds. This is how long it MUST take the flow pump to completely fill a balancing chamber and cause a deadhead.

**#78 Flow Pump Relief Valve:** Located in the output circuit of the flow pump #21. This valve prevents the flow pump from creating excessive pressure. It is mechanically adjusted to 29-30 PSI or 35-36 PSI (depending upon if the machine is Diasafe<sup>®</sup> Filter equipped).

**Valve #30 (drain valve):** Always open in Dialysis Program; in Cleaning Programs closes every 1.45 seconds in conjunction with valve #29 open; in Heat Disinfect, after pre-rinse time expires, it Valve #30 closes and remains closed and Valve #29 opens and remains open.

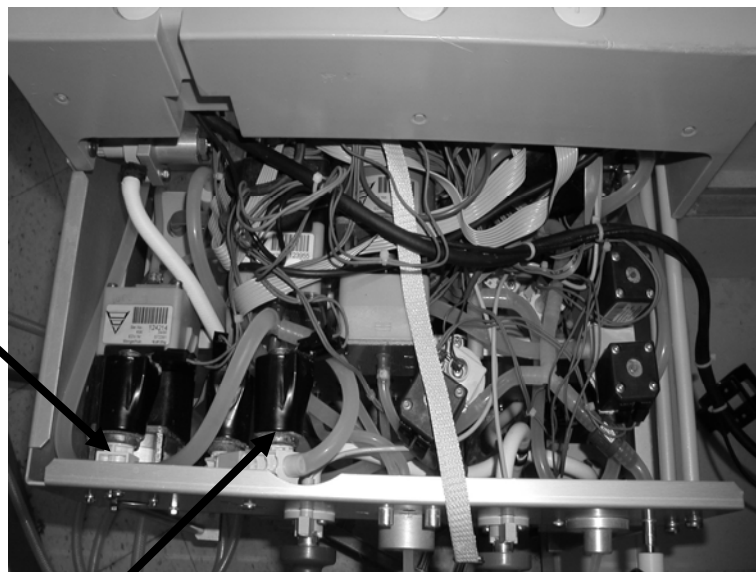

**Valve #29 (recirculation valve):** Closed in Dialysis Program; in Cleaning Programs opens every 1.45 seconds in conjunction with valve #30 (drain valve) closing.

*Section III – Hydraulic Description*

**Ultrafiltration (UF) Pump #22:** The UF pump is a piston-diaphragm pump that is ‘stroked’ by energizing and de-energizing a large solenoid. The pump is mechanically calibrated to deliver 1 ml/stroke. It is responsible for removing fluid (weight) from the patient.

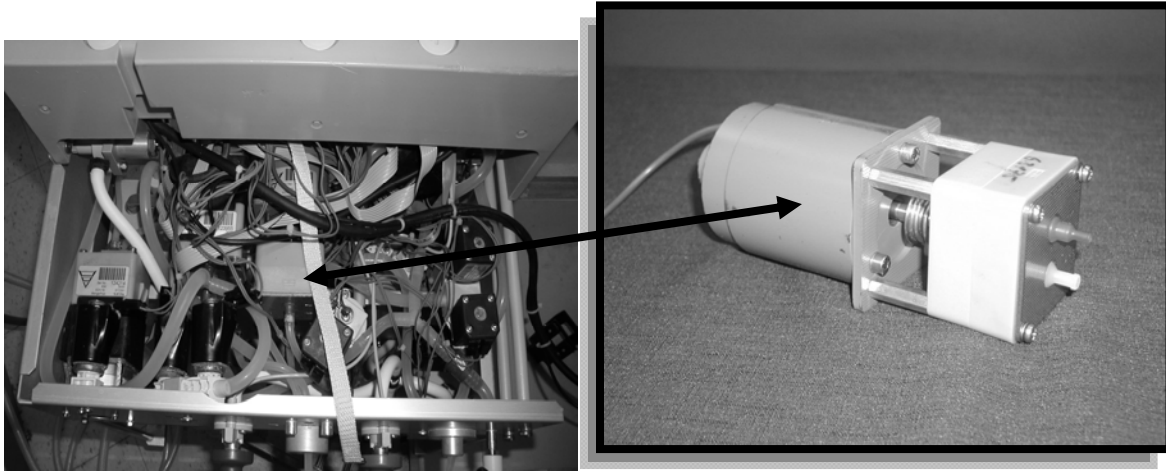

- Ultrafiltration Rate (UFR) = Pre-dialysis weight – (dry weight + fluid gained during treatment) Kg

**Valve #39:** Opens only in the Cleaning Programs. When open restrictor orifice #48 is bypassed and allows deaeration pump #20 to draw fluid directly out of chamber C. The result is a drastic decrease in deaeration pressure (drops to between 0 and -15 inHg). Primarily prevents boiling in Heat Disinfect.

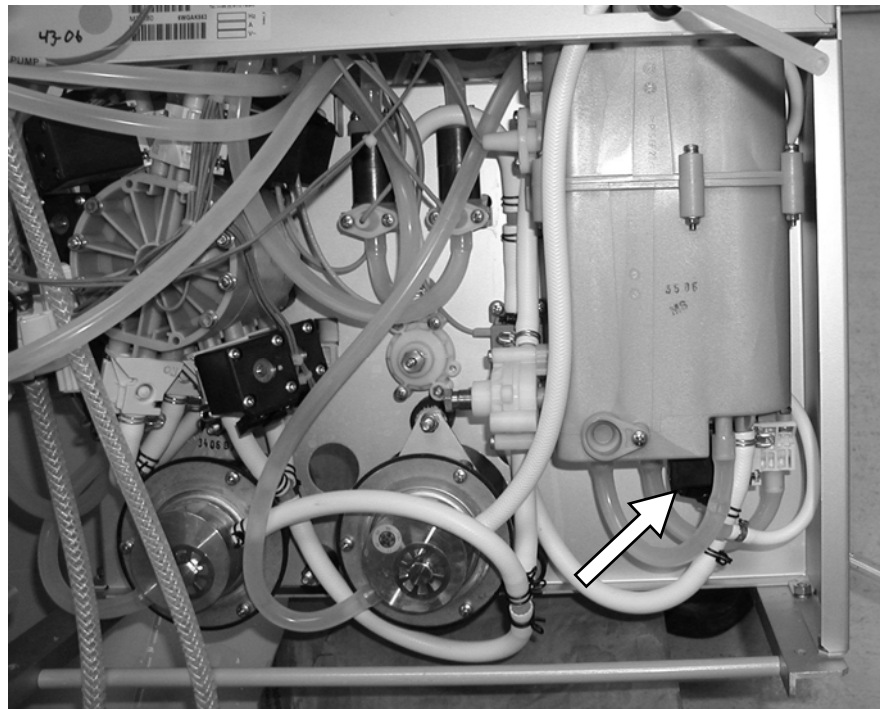

## **FILLING PROGRAM**

Filling programs are initiated by air in the separation chamber. Non-conductive solution (treated R.O. water) will also cause a filling program unless the machine is in a cleaning mode (rinse, chemical rinse, etc.)

### **Fill programs replace lost fluid in the chamber #69.**

The operator is informed with a warning message of:

FILLING PROGRAM

10 FILL PGM IN 1 HR

FILL PROGRAM MORE THAN ONE MINUTE

The UF pump is turned off during the complete fill cycle.

If a dialysate alarm is present valve 24 closes and valve 26 opens. If not valve 24 open and valve 26 closes. Spent valves 32 and 34 remain closed. The other balancing chamber valves cycle in a four-part sequence each lasting for 2.5 seconds independent of the CFS signal.

The filling program will continue until both probes are submersed in conductive solution. At which time the balancing chamber will resume its normal operation.

**FILL CYCLE 1a**

For 2.5 seconds valves 33, 35, 36 and 38 are open; valves 31 and 37 are closed; the flow pump is turned off.

Pump 20 fills the left side chamber with fresh fluid through valve 35 pushing its diaphragm to the right. This forces the spent fluid out valve 36 and in on valve 38 causing the right side diaphragm to force the fresh fluid out of valve 33 into chamber 69.

Filling programs will cause a positive pressure in the dialysate compartment. By monitoring this pressure with #9, the dialysate pressure transducer, when the pressure becomes positive it will open the vent valve #43 letting the air and excess pressure to the drain. When the pressure returns to zero it will close the valve #43. Valve 43 would open and close through the whole filling program dependent on the pressure on the #9 dialysate pressure transducer.

**FILL CYCLE 1b**

This cycle is the same as cycle one a except for valve # 36 closes and the flow pump is turned on. When the chamber full switch signal occurs this causes the actuator board to cycle the concentrate pumps. After 2.5 seconds if the probes are still not in conductive solution fill cycle two will become active.

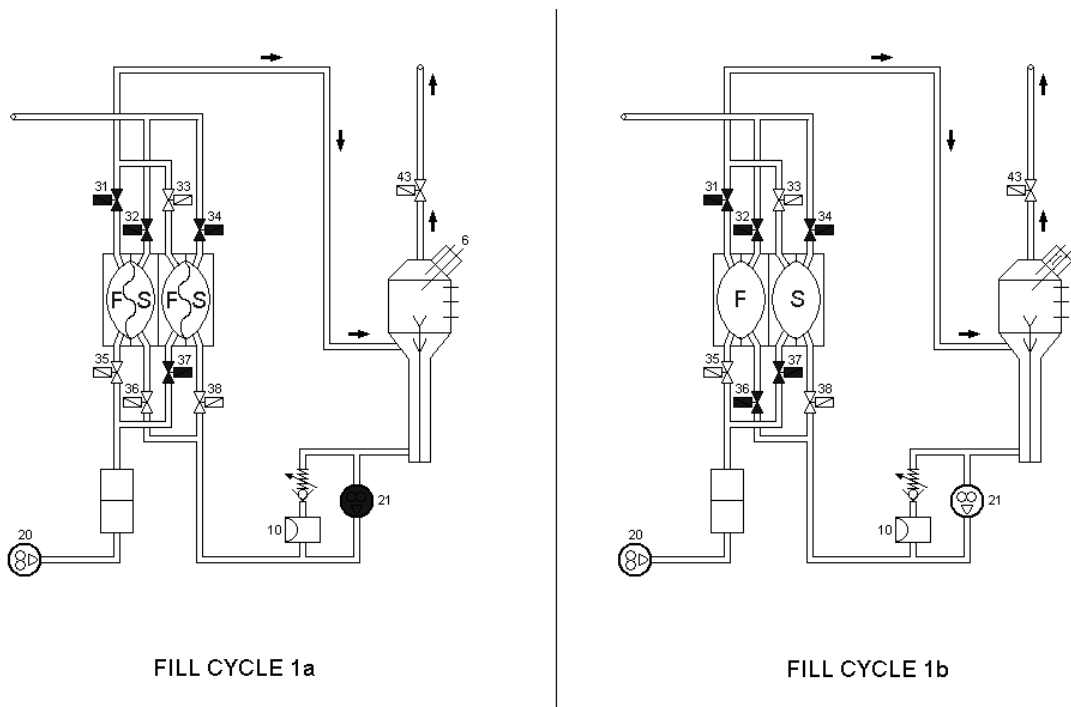

**FILL CYCLE 2.**

This cycle is the reverse of cycle one. The right side chamber fills with fresh fluid forcing spent into the left side chamber and fresh fluid into chamber 69. After 5 seconds if the probes are still not in conductive solution the whole process will repeat until they are both submersed.

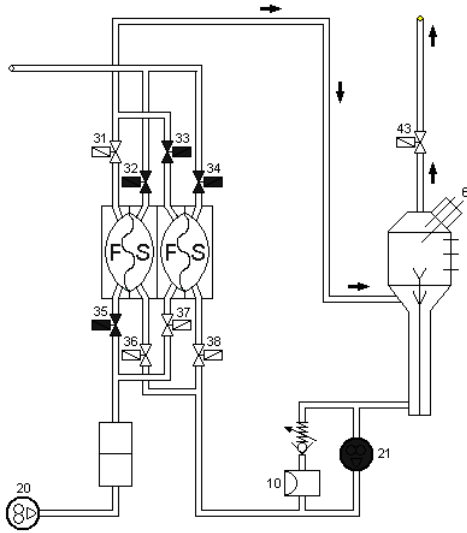

FILL CYCLE 2a

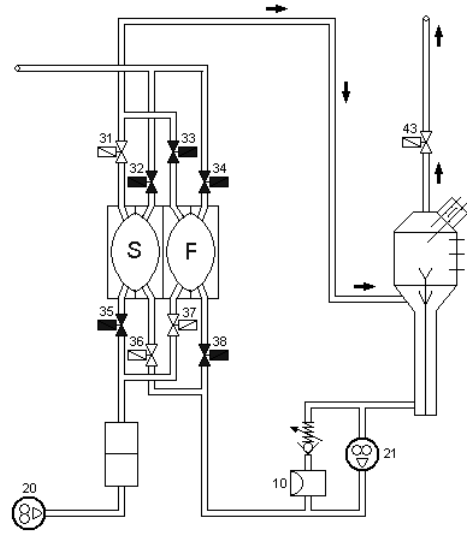

FILL CYCLE 2b

## **HYDRAULIC DESCRIPTION**

### **Identification & Calibration Lab Exercise**

Purpose: This exercise is to 1) identify the hydraulic components using the following pages and documenting on the check list at the end of the section, and 2) calibrate all required parameters and documenting on the check list at the end of the section.

#### Lab Rules

While working with the machines it is important that you follow a few basic rules.

1. Please do not place tools, screws, or drinks of any kind on top of the machine. You should never set anything with fluid in it (such as cups or graduated cylinders) on top of the machine.
2. When removing boards from the electronics card cage ALWAYS turn the power off first and ground yourself before initial contact with the board.

#### ***Warning! Electro Static Discharge PRECAUTIONS REQUIRED***

3. Whenever moving the dialyzer lines on or off the shunt door assure that the card cage is pushed into the machine first.
4. Be Careful. The machine is an electronic device and a shock hazard always exists.

COMPLETE CHECK LIST AT END OF THIS HANDOUT AND GIVE TO INSTRUCTOR WHEN FINISHED WITH LAB EXERCISE.







**ELECTRONICS CARD CAGE:**

- Open the **card cage** and lay the front panel down (if you don't know how ask the instructor)
- Identify all boards including the **motherboard**, see picture below.
- Locate the display, display interface, and front panel assemblies.

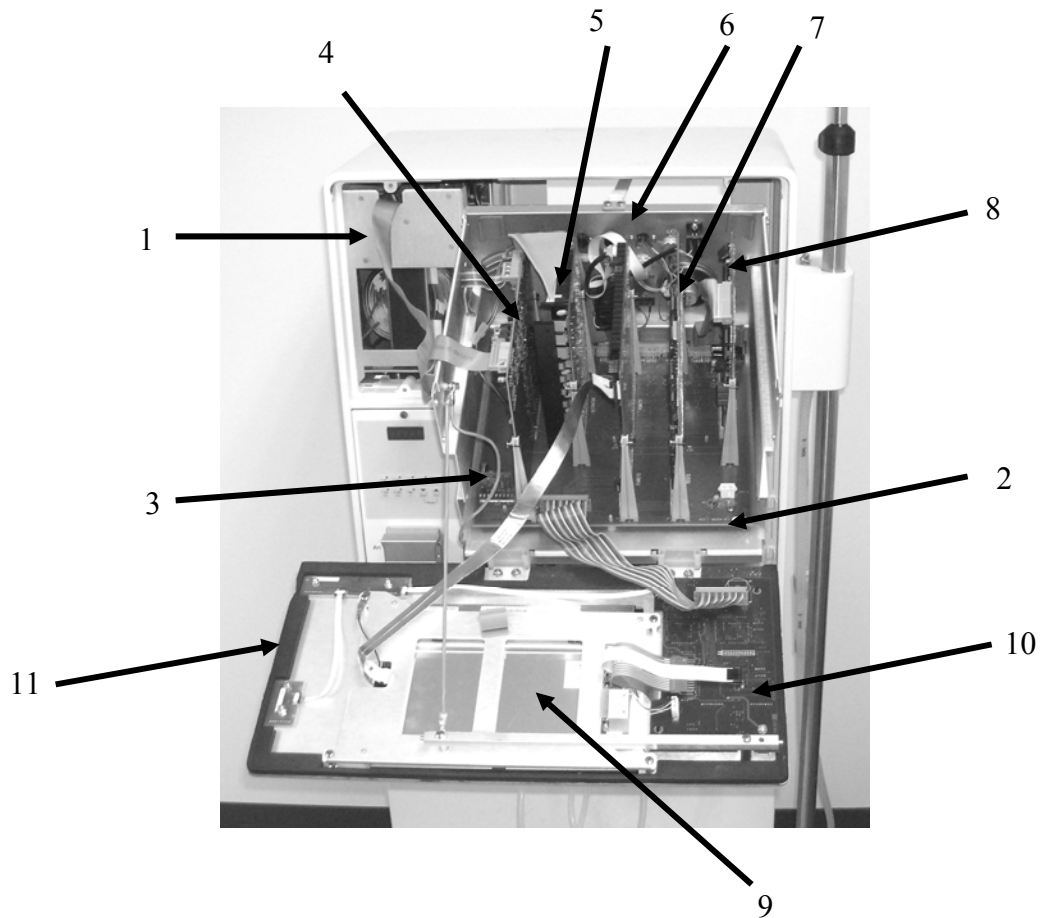

- 1 = Power Supply
- 2 = Mother Board
- 3 = -12V Inverter Board
- 4 = Power Logic Board
- 5 = Actuator Board
- 6 = Functional Board
- 7 = Test Board
- 8 = Sensor Board
- 9 = Liquid Crystal Display
- 10 = Display Interface Board
- 11 = Front Panel Assembly

### Section III – Hydraulic Description

#### UPPER POWER SUPPLY:

- Locate the upper power supply. UNPLUG the machine and carefully pull the power supply out the back of the machine leaving it supported on the shelf.
- Locate the Main Transformer, Power Control Board, and the TRIAC (have the instructor help you find the TRIAC if necessary).
- Place the power supply back into the cabinet

#### DISTRIBUTION BOARD

- Locate the distribution board and trace the actuator and sensor cables to their termination.
  - All Hydraulic components receive power from the distribution board
  - Hydraulic components connections correlate to the flow diagram identification numbers (i.e. NTC #2 plugs into position #2 **THERE IS NO POSITION #1**)
  - Locate #2 in the distribution board and note that the connector position is labelled “CON-NTC”
1. Locate Valve 30’s position in the distribution board and unplug it.
  2. Note there are five male pins in the distribution board numbered 1 -5 top to bottom.
  3. At the female connector measure resistance between pins 1 (top) and 5 (bottom). This is valve 30’s solenoid coil resistance (approx.  $60\Omega$ ).
  4. Plug valve back into the CORRECT position.
  5. Note the 110V AC connections for the HEATER ELEMENT inside the 8 pin green connector on the far right of the distribution board.
  6. Measure resistance between the BLUE and BROWN wires. This is the heater’s internal resistance (approx.  $10\Omega$ ).

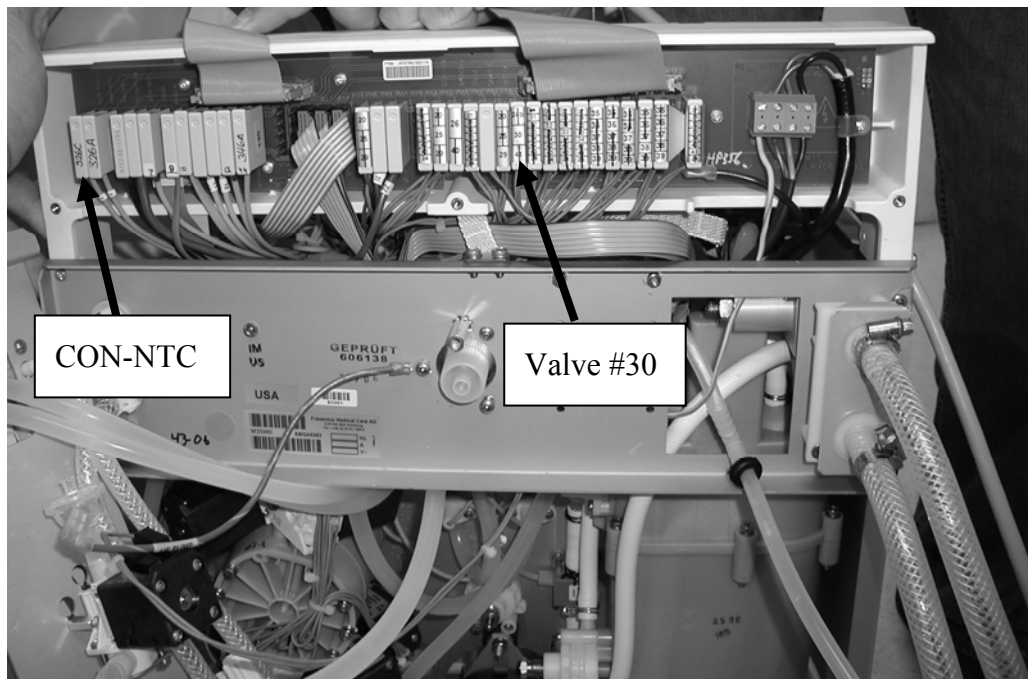

**Hydraulics:**

During this exercise you will review hydraulic theory once again but this time with the machine. Flow is traced from where water enters the machine all the way through to the drain. Many (but not all) of the Calibration and Preventative Maintenance (PM) procedures will be performed. At times you will be asked questions. Please verify your answers with the instructor. At other times you will be asked to illustrate what you have learned with the instructor. Use the flow diagram and this workbook as a guide through the hydraulics. Good luck and have fun!

1) FIND THE INCOMING WATER LINE TO THE BACK OF THE MACHINE

This line may contain the optional filter which, if present, is located in the incoming water line connection at the water supply.

2) LOCATE & THE INLET WATER REGULATOR #61 (Inlet Water Regulator)

Calibrate the inlet water pressure to 18 to 20 PSI as per the Calibration Procedure Manual and sign off on the check list.

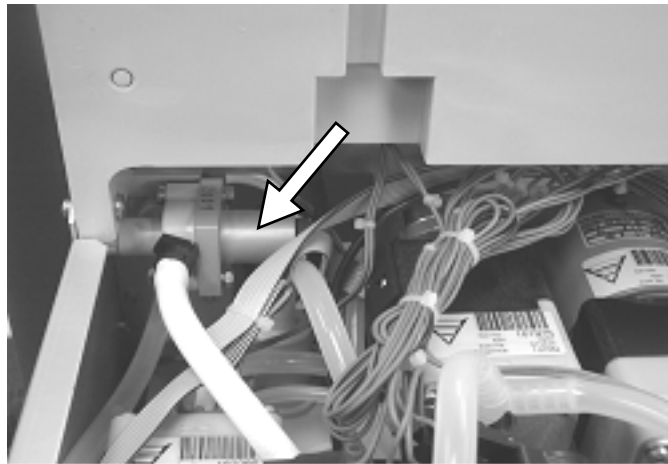

*Section III – Hydraulic Description*

3) LOCATE THE HEAT EXCHANGER #77 (Heat Exchanger)

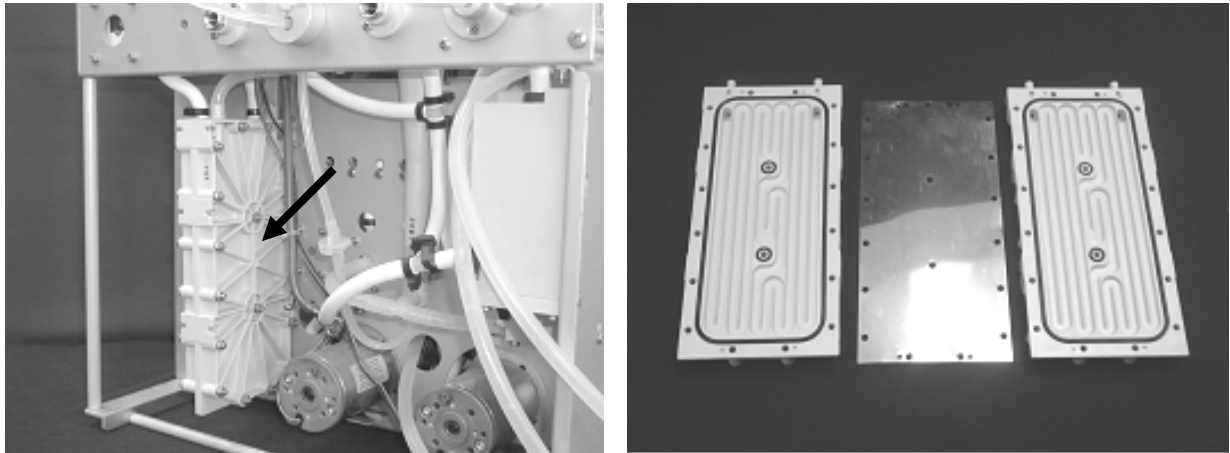

Locate the FRESH input and output and the SPENT input and output (note that the FRESH side is under high pressure and utilizes white reinforced tubing)

4) Locate SOLENOID VALVES #41(#27) & #29  
#41(Incoming Water Valve) / #29 (Recirculation Valve)

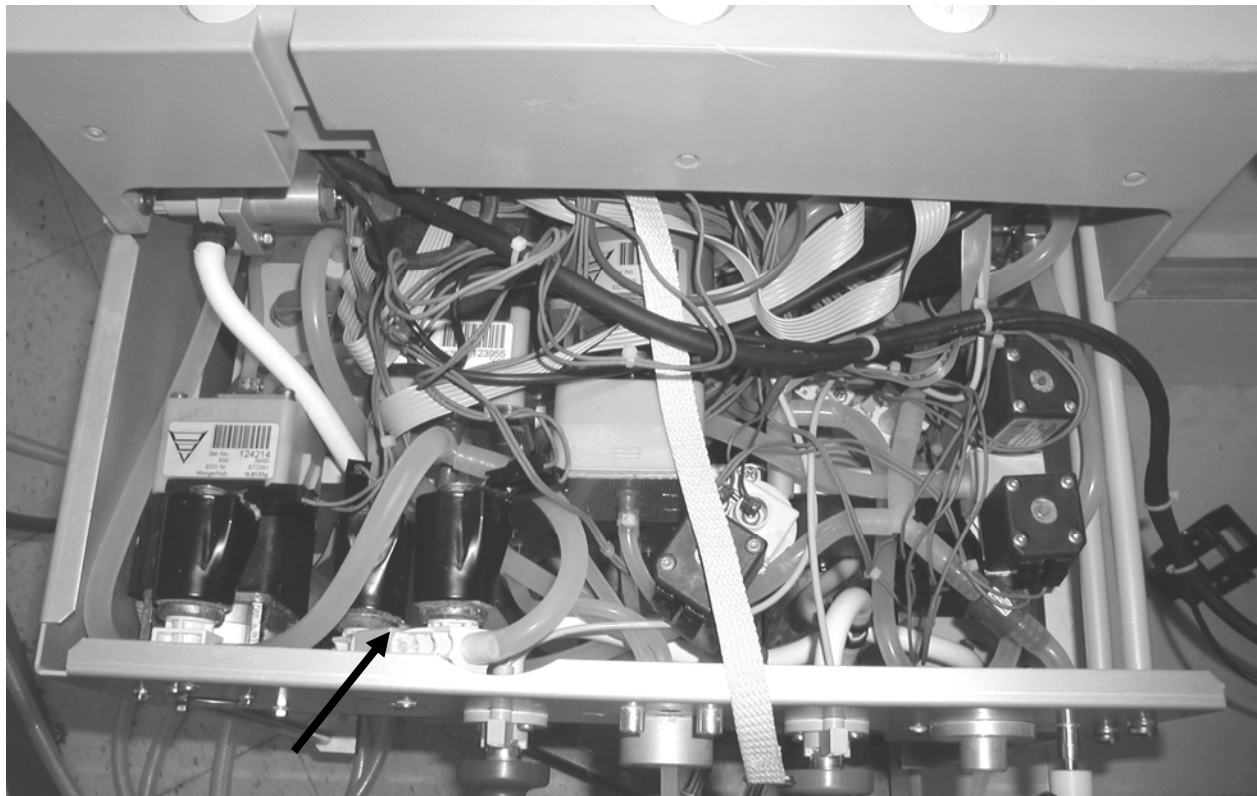

- 5) LOCATE Chamber A (Incoming Water) OF THE HYDROBLOCK OR CHAMBER  
LOCATE THE AIR GAP AND VENT TUBE
- 6) LOCATE THE HEATER AND NTC#2 IN Chamber B (Heater Chamber)  
Heater #54 AND THE 120V AC CONNECTIONS  
NTC #2 (Heater Control Thermistor) mounted at the side of the chamber

Perform temperature calibrations as per check list and calibration manual – after all hydraulic pressures are good.

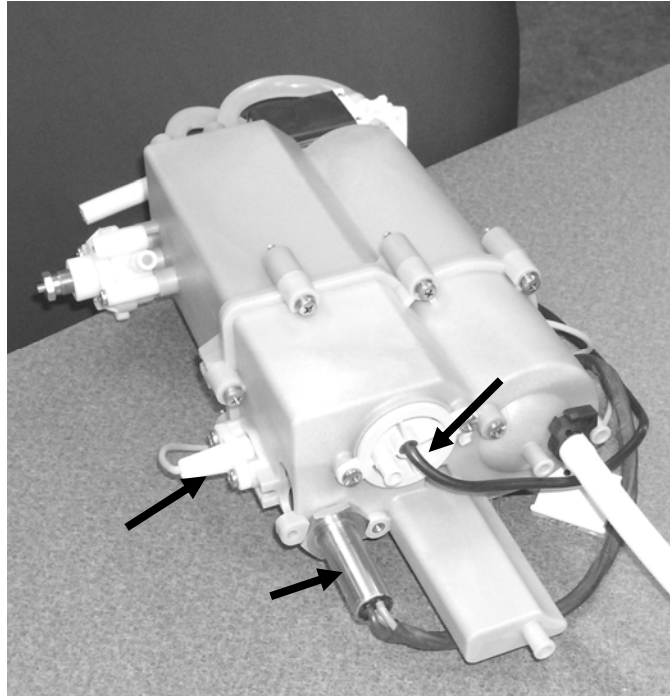

**Chamber C (Float Chamber)**

The float chamber contains **the float switch #5**. It is made up of two components. One is the float ‘bob’ with an embedded magnet. The second is the reed switch that is located at the end of the shaft. When the float drops the magnet closes the reed switch causing the inlet water valve (41/27) to open. When the float rises the magnet ceases to influence the switch causing the contacts to open and close the valve (41/27.)

- 7) LOCATE THE FLOAT IN Chamber C (Float Chamber) ‘see picture above’

*Section III – Hydraulic Description*

- 8) LOCATE THE DEAERATION PUMP #20 & LOADING PRESSURE RELIEF VALVE #65.

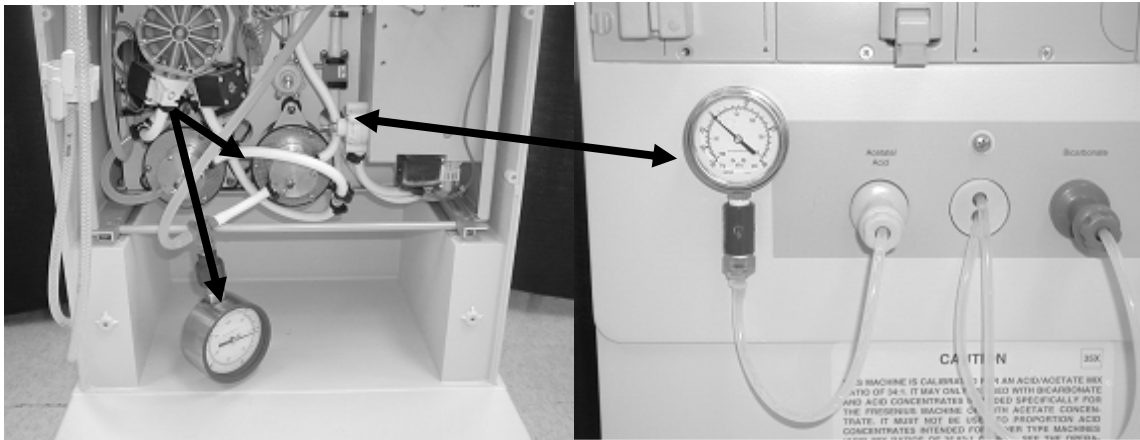

The loading pressure regulator (#65), located on the side of chamber A, opens when pressure reaches the target setting of 24 – 25 PSI (Loading Pressure). When the regulator opens air and excess pressure is vented back into chamber A where air is released to atmosphere via the vent tube.

Calibrate Loading and Deaeration Pressure as per the Calibration Procedure Manual.

- 9) LOCATE THE BYPASS FOR DEAERATION VALVE #39 (Vacuum Release Valve)

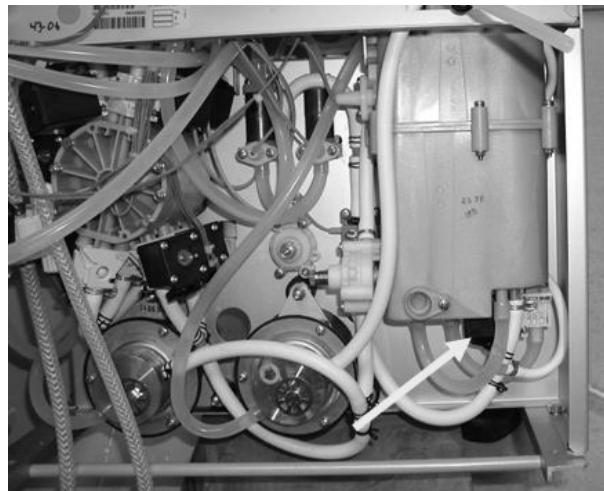

- 10) LOCATE THE CONCENTRATE PUMPS AND THEIR INPUTS AND OUTPUTS  
#16 (Concentrate Pump) and #17 (Bicarb Pump)

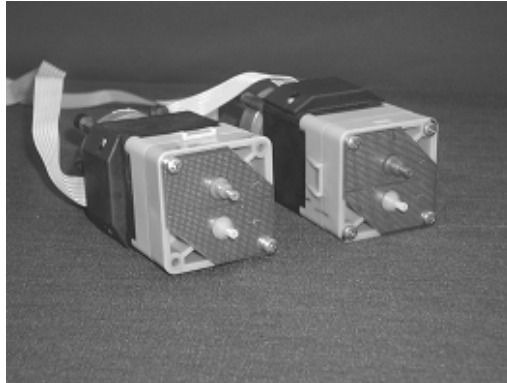

Tell the instructor if your machine is equipped with OLC by locating the acid injection site. Pump volumes should be calibrated as per the check list and the calibration manual.

- 11) LOCATE THE FILTERS FOR THE ACID AND BICARBONATE INTAKE  
#71(Acid Filter) and #72 (Bicarb Filter)



- 12) LOCATE THE ACID AND BICARB. RINSE PORTS & REED SWITCHES  
#11 and #12 (Reed Switches)

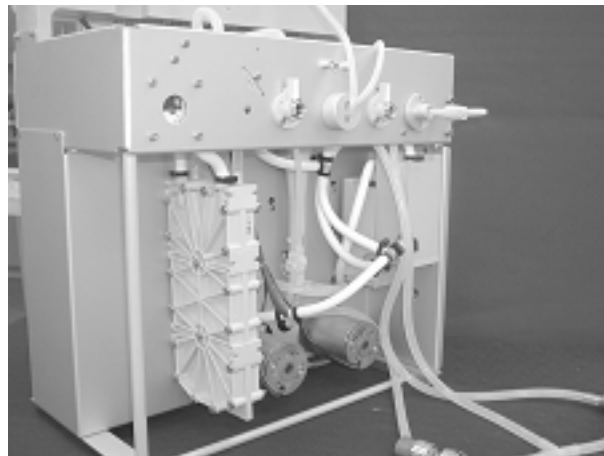

*Section III – Hydraulic Description*

- 13) LOCATE THE MIXING CHAMBER OR CHAMBERS  
#82 (Mixing Chamber)



Why would there possibly be two mixing chambers?

---

- 14) LOCATE & CALIBRATE THE BALANCE CHAMBER. ALSO IDENTIFY THE INPUT & OUTPUT VALVES

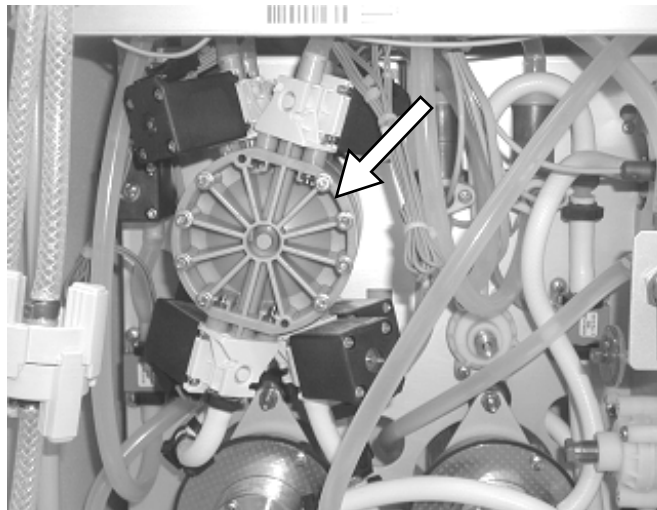

BALANCING CHAMBER #68

Where are the OUTPUT VALVES 31 – 34? \_\_\_\_\_

Where are the INPUT VALVES 35 – 38? \_\_\_\_\_



- 15) LOCATE CONDUCTIVITY CELL & NTC#3  
#7 (Pre Dialyzer conductivity cell)  
NTC #3 (Pre dialyzer temperature thermistor)  
Calibrate conductivity as per the check list and the calibration manual.

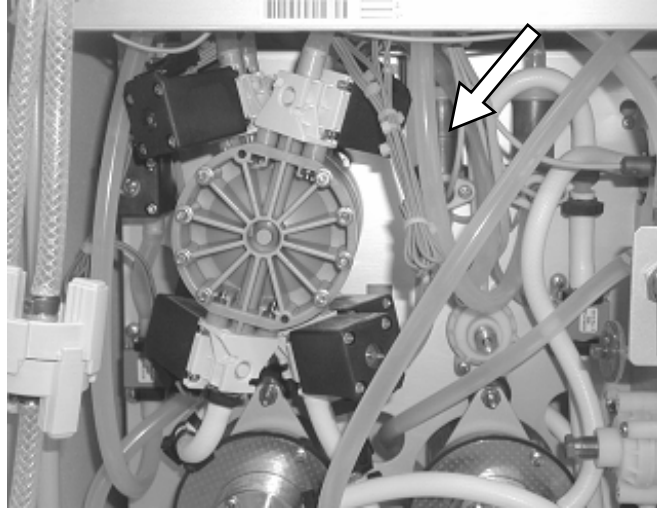

- 16) LOCATE DIASAFE TEST VALVE AND THE DIASAFE FILTER

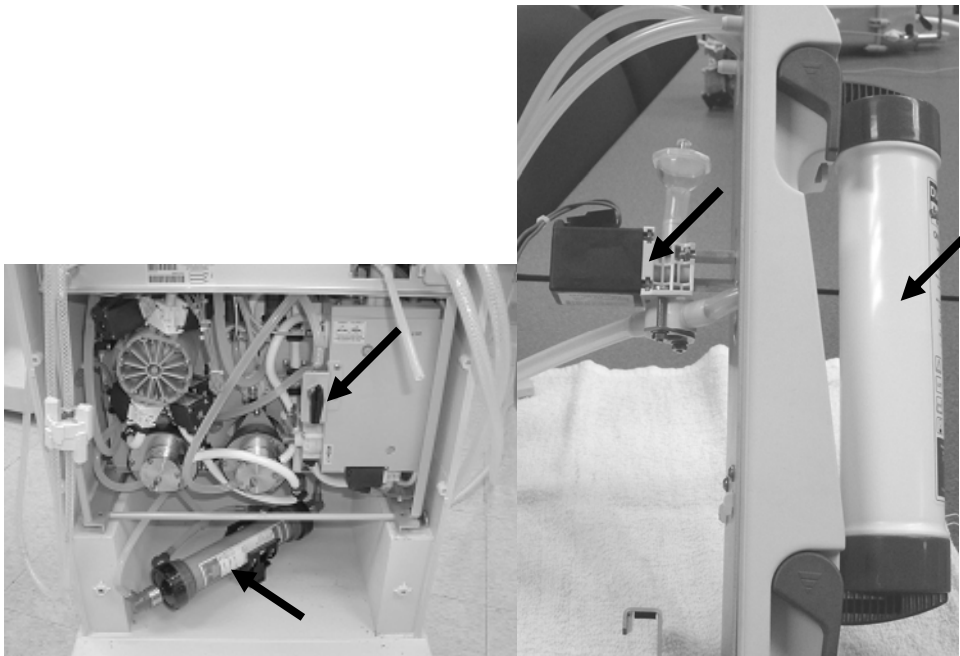

- #91 or 28 (Three Way Valve)  
#92 (Transducer Protector)  
#90 (Diasafe Filter)

What does the Diasafe Filter do? \_\_\_\_\_

*Section III – Hydraulic Description*

- 17) LOCATE AND IDENTIFY THE VALVE 24 / 26 PAIR  
#24 & #26 (Dialyzer Valve I (24) & Bypass Valve (26))



Tell the instructor which one is which.

- 18) LOCATE THE DIALYSATE LINE FLOW INDICATOR  
#75 (External Flow Indicator)



- 19) LOCATE THE SHUNT DOOR AND REED SWITCHES  
Dialysate Connectors and Shunt Door Switches

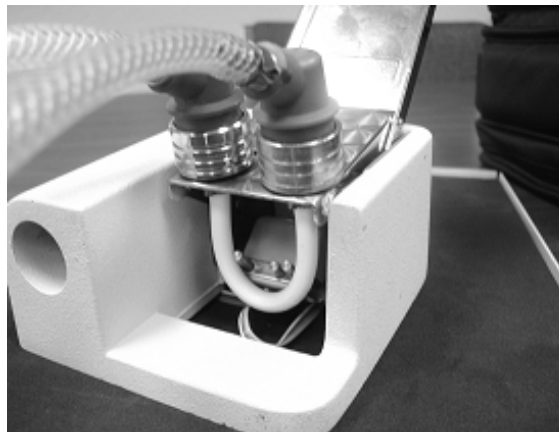

Why do we need shunt door switches? \_\_\_\_\_

- 20) LOCATE THE DIALYZER LINE FILTER  
#73 (Arterial dialysate line filter)

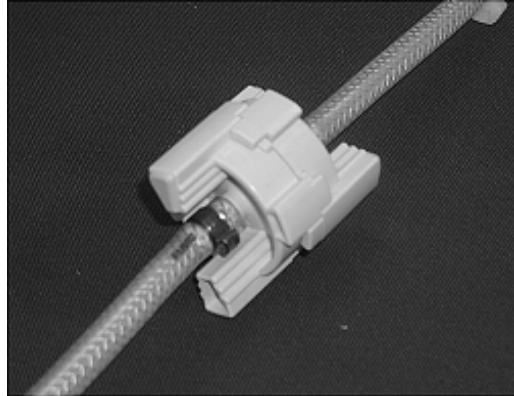

- 21) LOCATE VALVE 25  
#25 (Dialyzer Valve II)

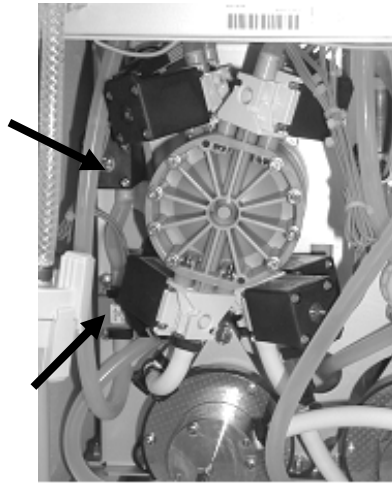

- 22) LOCATE THE DIALYSATE PRESSURE TRANSDUCER  
#9 (Dialysate Pressure Transducer) (see picture above)  
*Perform the Dialysate pressure calibration as per the check list and the calibration manual.*

- 23) LOCATE & CALIBRATE THE BLOOD LEAK DETECTOR  
#8 (Blood Leak Detector)



*Section III – Hydraulic Description*

- 24) IF PRESENT, LOCATE THE POST CONDUCTIVITY AND TEMPERATURE SENSORES FOR OLC  
#13 AND #44 (Post Temperature Sensor and Post Conductivity Cell)

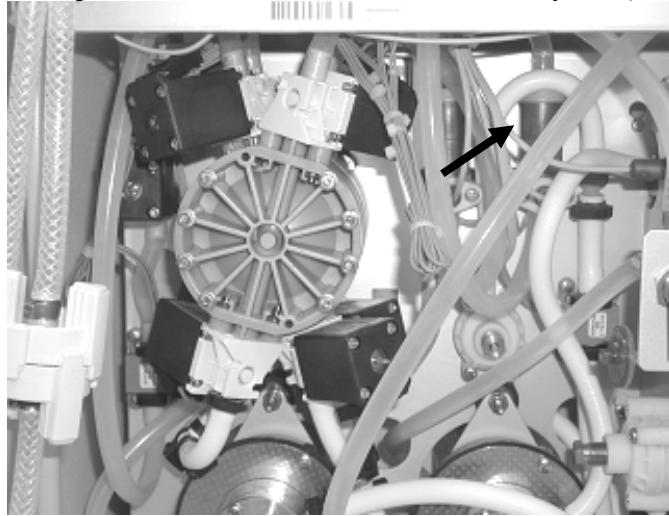

Perform the post temperature sensor calibration, if these components are present, as per the check list and the calibration manual.

- 25) LOCATE THE AIR SEPARATION CHAMBER

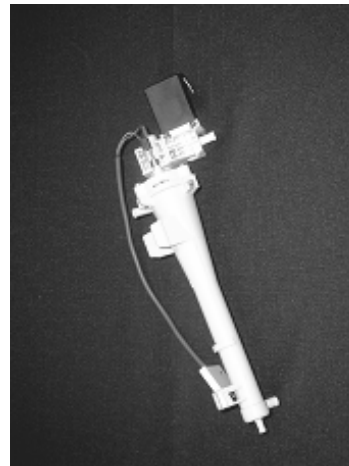
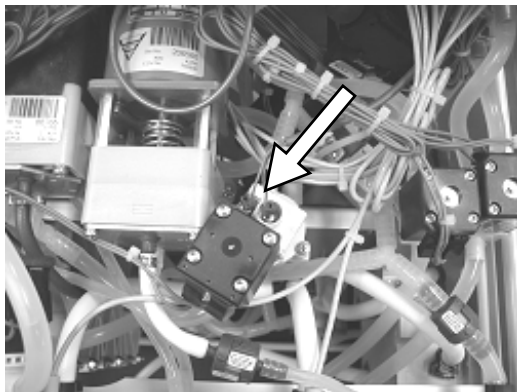

- #69 (Air Separation Chamber)  
#6 (Air Sensor blue and brown wire connections)  
#43 (Vent Valve)

- 26) Follow the output from #69 on the bottom side and LOCATE THE FLOW PUMP #21 (FLOW PUMP)

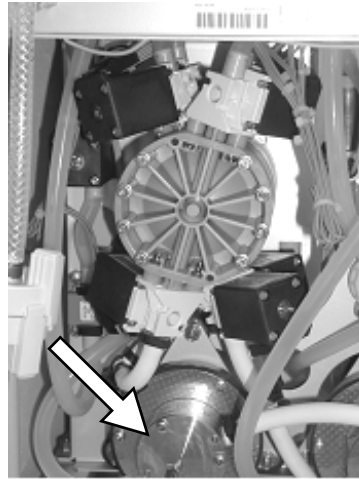

- 27) Follow the output of the Flow pump to the tee and up to the CHAMBER FULL SWITCH (Pressure Transducer) #10 (CFS TRANSDUCER)

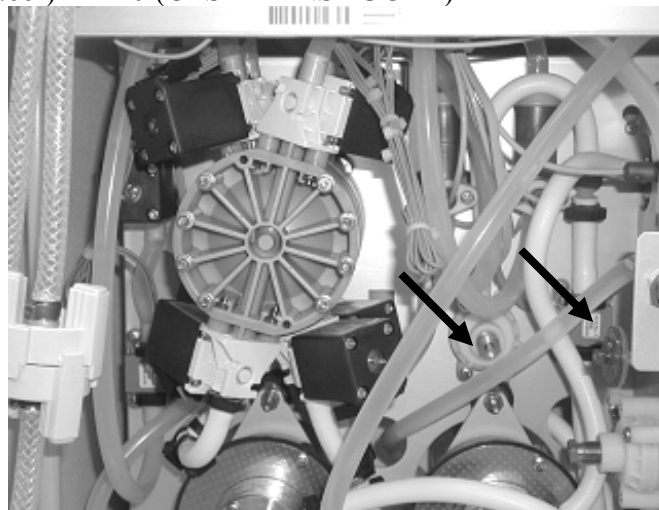

- 28) LOCATE & CALIBRATE THE FLOW PUMP PRESSURE RELIEF VALVE #78 (Flow Pump Relief Valve) (see picture above)  
Mechanically adjust to 35-36 PSI as per the calibration procedure.

The output of this regulator goes through the hydraulic chassis wall and tees back into the line that feeds the input to the FLOW PUMP. Trace this back to the Flow Pump and then to the output and the output tee. From here now go to the Balancing Chamber and find the output spent valves 32 & 34.

Trace the line past the tee to the heat exchanger spent input to output and then...

*Section III – Hydraulic Description*

29) LOCATE AND IDENTIFY THE DRAIN VALVE

#30 (Drain Valve) show the instructor where this valve is located

Now go back to the Air Separation Chamber and go to the small output port on the extreme bottom of the chamber. Flow this line and find...

30) LOCATE THE PRE-UF FILTER #74 (Pre-UF FILTER)

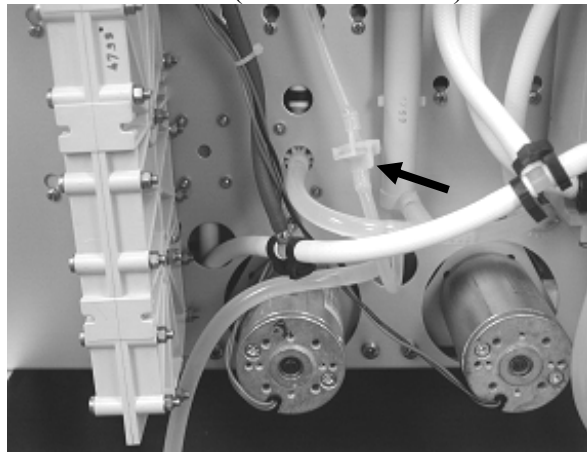

31) LOCATE and Calibrate THE UF PUMP  
#22 (Ultra Filtration Pump or UF Pump)

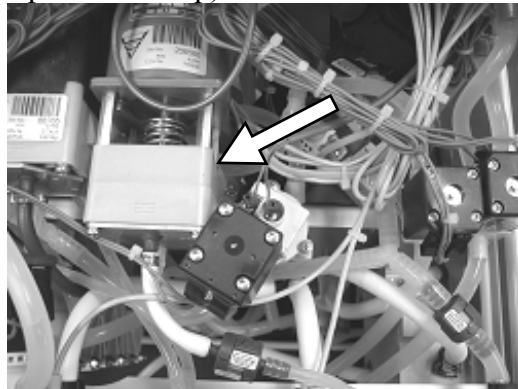

Find the hydraulic input and output but also locate the mechanical adjustment on the opposite end of the pump.

Back to the hydraulic end follow the output of the UF pump to the next component.

32) LOCATE CHECK VALVE FROM UF PUMP TO SAMPLE PORT  
#63 (Check Valve) see picture above

33) LOCATE CHECK VALVE FROM SAMPLE PORT TO DRAIN  
#64 (Check Valve) see picture above

**THIS PAGE LEFT BLANK INTENTIONALLY**

**Calibration & Identification Check List (Instructor’s Copy)**

Level I

**Print Name** \_\_\_\_\_

**Initial** next to each item as your group completes each line item. When all calibrations are complete return to dialysis mode and **run Self Test**. When Test passes inform instructor that your group is finished and the Test has passed. If the test does not pass attempt to address the problem and contact the instructor for assistance.

**IDENTIFICATIONS:**

- Electronics card cage ID complete ..... *initials* \_\_\_\_\_
- Main Power supply ID complete ..... *initials* \_\_\_\_\_
- Inlet Water Line & Filter ..... *initials* \_\_\_\_\_
- #77 Heat Exchanger ..... *initials* \_\_\_\_\_
- Solenoid Valve Pair 41 / 29 ..... *initials* \_\_\_\_\_
- Chamber A ..... *initials* \_\_\_\_\_
- Heater & NTC#2 ..... *initials* \_\_\_\_\_
- The Float in Chamber C ..... *initials* \_\_\_\_\_
- Bypass Valve for Deaeration ..... *initials* \_\_\_\_\_
- Concentrate Pumps ..... *initials* \_\_\_\_\_
- Filters for Acid & Bicarb intake ..... *initials* \_\_\_\_\_
- Acid & Bicarb Rinse Ports & Reed Switches ..... *initials* \_\_\_\_\_
- Mixing Chamber or Chambers ..... *initials* \_\_\_\_\_
- Balancing Chamber Assembly ..... *initials* \_\_\_\_\_
- Conductivity Cell & NTC#3 ..... *initials* \_\_\_\_\_
- Diasafe Filter & Diasafe Test Valve ..... *initials* \_\_\_\_\_
- Valve Pair 24 / 26 ..... *initials* \_\_\_\_\_
- External Flow Indicator ..... *initials* \_\_\_\_\_
- Shunt Door and Switches ..... *initials* \_\_\_\_\_
- External Line Filter ..... *initials* \_\_\_\_\_
- Valve 25 ..... *initials* \_\_\_\_\_
- Dialysate Pressure Transducer ..... *initials* \_\_\_\_\_
- Blood Leak Detector ..... *initials* \_\_\_\_\_
- Post Conductivity and NTC ..... *initials* \_\_\_\_\_
- Air Separation Chamber ..... *initials* \_\_\_\_\_
- Flow Pump ..... *initials* \_\_\_\_\_
- Chamber Full Switch (CFS) ..... *initials* \_\_\_\_\_
- Flow Relief Valve ..... *initials* \_\_\_\_\_
- Drain Valve ..... *initials* \_\_\_\_\_
- Pre – UF Filter ..... *initials* \_\_\_\_\_
- UF Pump ..... *initials* \_\_\_\_\_
- Check Valves ..... *initials* \_\_\_\_\_

Continue to next page to complete all Calibrations!



**Calibration & Identification Check List (Instructor’s Copy) Cont...**

**Hydraulic calibrations**

1. Inlet Water Regulator - Inlet water pressure 18 - 20psi (**dialysis mode**) **Calibration complete**  
*Enter reading from pressure gauge* \_\_\_\_\_ *initials* \_\_\_\_\_
2. Deaeration & Loading pressure
  - a. Deaeration **\*at sea level\*** -24inHg  
*Enter reading from pressure gauge* \_\_\_\_\_ *initials* \_\_\_\_\_
  - b. Loading Pressure 24.5 psi  
*Enter reading from pressure gauge* \_\_\_\_\_ *initials* \_\_\_\_\_
3. Flow Pump Relief Pressure 35 – 36 psi  
*Enter reading from pressure gauge* \_\_\_\_\_ *initials* \_\_\_\_\_
4. Balance Chamber volume  
*Enter volume measured* \_\_\_\_\_ *initials* \_\_\_\_\_
5. Acid pump volume  
*Enter volumes measured* 1) \_\_\_\_\_ 2) \_\_\_\_\_ *initials* \_\_\_\_\_
6. Bicarbonate pump volume  
*Enter volumes measured* 1) \_\_\_\_\_ 2) \_\_\_\_\_ *initials* \_\_\_\_\_
7. UF Pump volume 1cc/stroke  
*Enter volume measured* \_\_\_\_\_ *initials* \_\_\_\_\_

**Sensor Calibrations**

1. Arterial Pressure Calibration *initials* \_\_\_\_\_
2. Venous Pressure Calibration *initials* \_\_\_\_\_
3. Dialysate Pressure Calibration *initials* \_\_\_\_\_
4. Temperature Sensor Calibration *initials* \_\_\_\_\_
5. Post Temperature Sensor Calibration (if applicable) *initials* \_\_\_\_\_
6. Temperature Control Calibration *initials* \_\_\_\_\_
7. Blood Leak Calibration *initials* \_\_\_\_\_
8. Conductivity Cell(s) Calibration *initials* \_\_\_\_\_

**Monitor Calibrations**

1. Set Clock ( service mode or dialysis under B.P. screen) *initials* \_\_\_\_\_
2. Voltage Detection *voltage reading* \_\_\_\_\_ *initials* \_\_\_\_\_
3. Arterial Pump Rate *initials* \_\_\_\_\_

**CALIBRATION DONE IN DIALYSIS MODE!**

Level Detector Calibration (channel 1 and channel 2) (**dialysis mode**) *initials* \_\_\_\_\_

**SIGNATURE** \_\_\_\_\_

By signing this form you are verifying that you have completed this lab and are able to perform the calibrations listed.

**Turn in form to instructor when all calibrations are complete.**

**THIS PAGE LEFT BLANK INTENTIONALLY**

**Calibration & Identification Check List (Student’s Copy)**

Level I

**Print Name** \_\_\_\_\_

**Initial** next to each item as your group completes each line item. When all calibrations are complete return to dialysis mode and **run Self Test**. When Test passes inform instructor that your group is finished and the Test has passed. If the test does not pass attempt to address the problem and contact the instructor for assistance.

**IDENTIFICATIONS:**

- Electronics card cage ID complete ..... *initials* \_\_\_\_\_
- Main Power supply ID complete ..... *initials* \_\_\_\_\_
- Inlet Water Line & Filter ..... *initials* \_\_\_\_\_
- #77 Heat Exchanger ..... *initials* \_\_\_\_\_
- Solenoid Valve Pair 41 / 29 ..... *initials* \_\_\_\_\_
- Chamber A ..... *initials* \_\_\_\_\_
- Heater & NTC#2 ..... *initials* \_\_\_\_\_
- The Float in Chamber C ..... *initials* \_\_\_\_\_
- Bypass Valve for Deaeration ..... *initials* \_\_\_\_\_
- Concentrate Pumps ..... *initials* \_\_\_\_\_
- Filters for Acid & Bicarb intake ..... *initials* \_\_\_\_\_
- Acid & Bicarb Rinse Ports & Reed Switches ..... *initials* \_\_\_\_\_
- Mixing Chamber or Chambers ..... *initials* \_\_\_\_\_
- Balancing Chamber Assembly ..... *initials* \_\_\_\_\_
- Conductivity Cell & NTC#3 ..... *initials* \_\_\_\_\_
- Diasafe Filter & Diasafe Test Valve ..... *initials* \_\_\_\_\_
- Valve Pair 24 / 26 ..... *initials* \_\_\_\_\_
- External Flow Indicator ..... *initials* \_\_\_\_\_
- Shunt Door and Switches ..... *initials* \_\_\_\_\_
- External Line Filter ..... *initials* \_\_\_\_\_
- Valve 25 ..... *initials* \_\_\_\_\_
- Dialysate Pressure Transducer ..... *initials* \_\_\_\_\_
- Blood Leak Detector ..... *initials* \_\_\_\_\_
- Post Conductivity and NTC ..... *initials* \_\_\_\_\_
- Air Separation Chamber ..... *initials* \_\_\_\_\_
- Flow Pump ..... *initials* \_\_\_\_\_
- Chamber Full Switch (CFS) ..... *initials* \_\_\_\_\_
- Flow Relief Valve ..... *initials* \_\_\_\_\_
- Drain Valve ..... *initials* \_\_\_\_\_
- Pre – UF Filter ..... *initials* \_\_\_\_\_
- UF Pump ..... *initials* \_\_\_\_\_
- Check Valves ..... *initials* \_\_\_\_\_

Continue to next page to complete all Calibrations!

**Calibration & Identification Check List (Student's Copy) Cont...**

**Hydraulic calibrations**

1. Inlet Water Regulator - Inlet water pressure 18 - 20psi (**dialysis mode**) **Calibration complete**  
*Enter reading from pressure gauge* \_\_\_\_\_ *initials* \_\_\_\_\_
2. Deaeration & Loading pressure
  - a. Deaeration **\*at sea level\*** -24inHg  
*Enter reading from pressure gauge* \_\_\_\_\_ *initials* \_\_\_\_\_
  - b. Loading Pressure 24.5 psi  
*Enter reading from pressure gauge* \_\_\_\_\_ *initials* \_\_\_\_\_
3. Flow Pump Relief Pressure 35 – 36 psi  
*Enter reading from pressure gauge* \_\_\_\_\_ *initials* \_\_\_\_\_
4. Balance Chamber volume  
*Enter volume measured* \_\_\_\_\_ *initials* \_\_\_\_\_
5. Acid pump volume  
*Enter volumes measured* 1) \_\_\_\_\_ 2) \_\_\_\_\_ *initials* \_\_\_\_\_
6. Bicarbonate pump volume  
*Enter volumes measured* 1) \_\_\_\_\_ 2) \_\_\_\_\_ *initials* \_\_\_\_\_
7. UF Pump volume 1cc/stroke  
*Enter volume measured* \_\_\_\_\_ *initials* \_\_\_\_\_

**Sensor Calibrations**

1. Arterial Pressure Calibration *initials* \_\_\_\_\_
2. Venous Pressure Calibration *initials* \_\_\_\_\_
3. Dialysate Pressure Calibration *initials* \_\_\_\_\_
4. Temperature Sensor Calibration *initials* \_\_\_\_\_
5. Post Temperature Sensor Calibration (if applicable) *initials* \_\_\_\_\_
6. Temperature Control Calibration *initials* \_\_\_\_\_
7. Blood Leak Calibration *initials* \_\_\_\_\_
8. Conductivity Cell(s) Calibration *initials* \_\_\_\_\_

**Monitor Calibrations**

1. Set Clock ( service mode or dialysis under B.P. screen) *initials* \_\_\_\_\_
2. Voltage Detection *voltage reading* \_\_\_\_\_ *initials* \_\_\_\_\_
3. Arterial Pump Rate *initials* \_\_\_\_\_

**CALIBRATION DONE IN DIALYSIS MODE!**

Level Detector Calibration (channel 1 and channel 2) (**dialysis mode**) *initials* \_\_\_\_\_

**SIGNATURE** \_\_\_\_\_

By signing this form you are verifying that you have completed this lab and are able to perform the calibrations listed.

**THIS PAGE LEFT BLANK INTENTIONALLY**



**SECTION IV**

**MACHINE OPERATION**









## **Overview**

The 2008K hemodialysis machine is designed to perform hemodialysis in hospitals, dialysis clinics, and at home with a qualified operator other than the patient. It can be used for patients suffering chronic or acute renal failure.

## **Function of the 2008K**

The 2008K is designed to provide hemodialysis treatment by controlling and monitoring both the dialysate and extracorporeal blood circuits.

In the extracorporeal blood circuit, the blood is continuously circulated from the patient through a dialyzer, where toxins are filtered out through a semi-permeable membrane, before being returned to the patient. During this process, the extracorporeal blood circuit is monitored for venous and arterial blood pressures, and for the presence of air and blood. The 2008K can also administer heparin evenly throughout the treatment.

In the dialysate circuit, the dialysate concentrates are mixed with purified water, heated, degassed, and delivered to the dialyzer. Balancing chambers ensure that the incoming flow of the dialysate is volumetrically equal to the outgoing flow in order to control ultrafiltration from the patient.

## **Organization of the 2008K**

The 2008K is designed for functional efficiency. The back of the machine houses the utility connections such as water source, drain, and electrical connections. By mounting them to the back, the water lines and power cord remain out of the way during treatment.

The front of the machine contains all of the controls the operator needs access to during hemodialysis. It can be broken down into three main sections. The top section contains the control panel and houses the computer that runs the treatment program. The middle section contains the modules used for the safe transmission of the blood to and from the dialyzer. Dialysate is the primary concern of the bottom section of the 2008K. Here the concentrates used to make up the dialysate are mixed and pumped to the dialyzer.

The following pages contain front and rear views of the 2008K and a brief description of the machine's features. You should familiarize yourself with the location and purpose of these features.

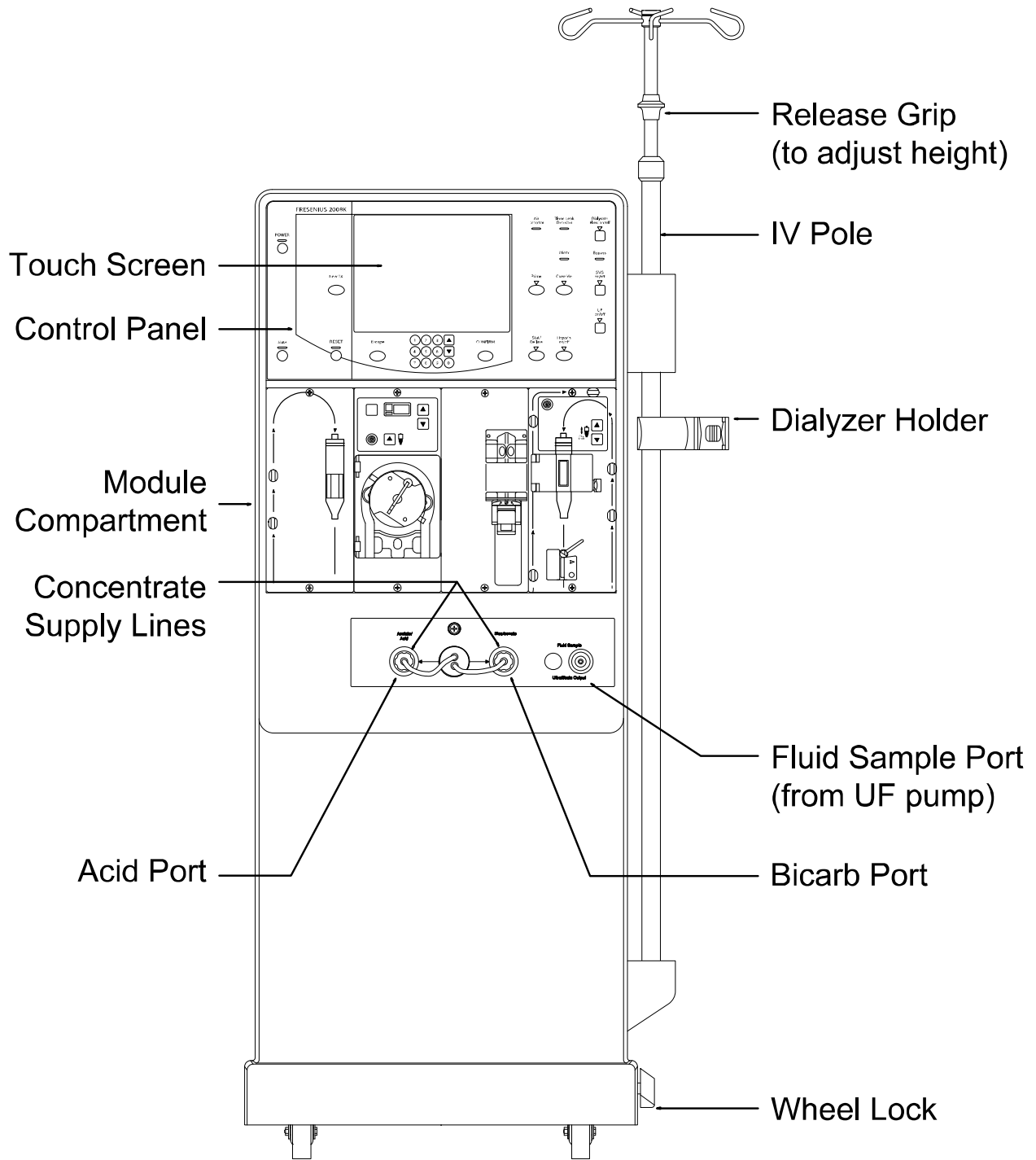

**2008K Hemodialysis Machine—Front View**

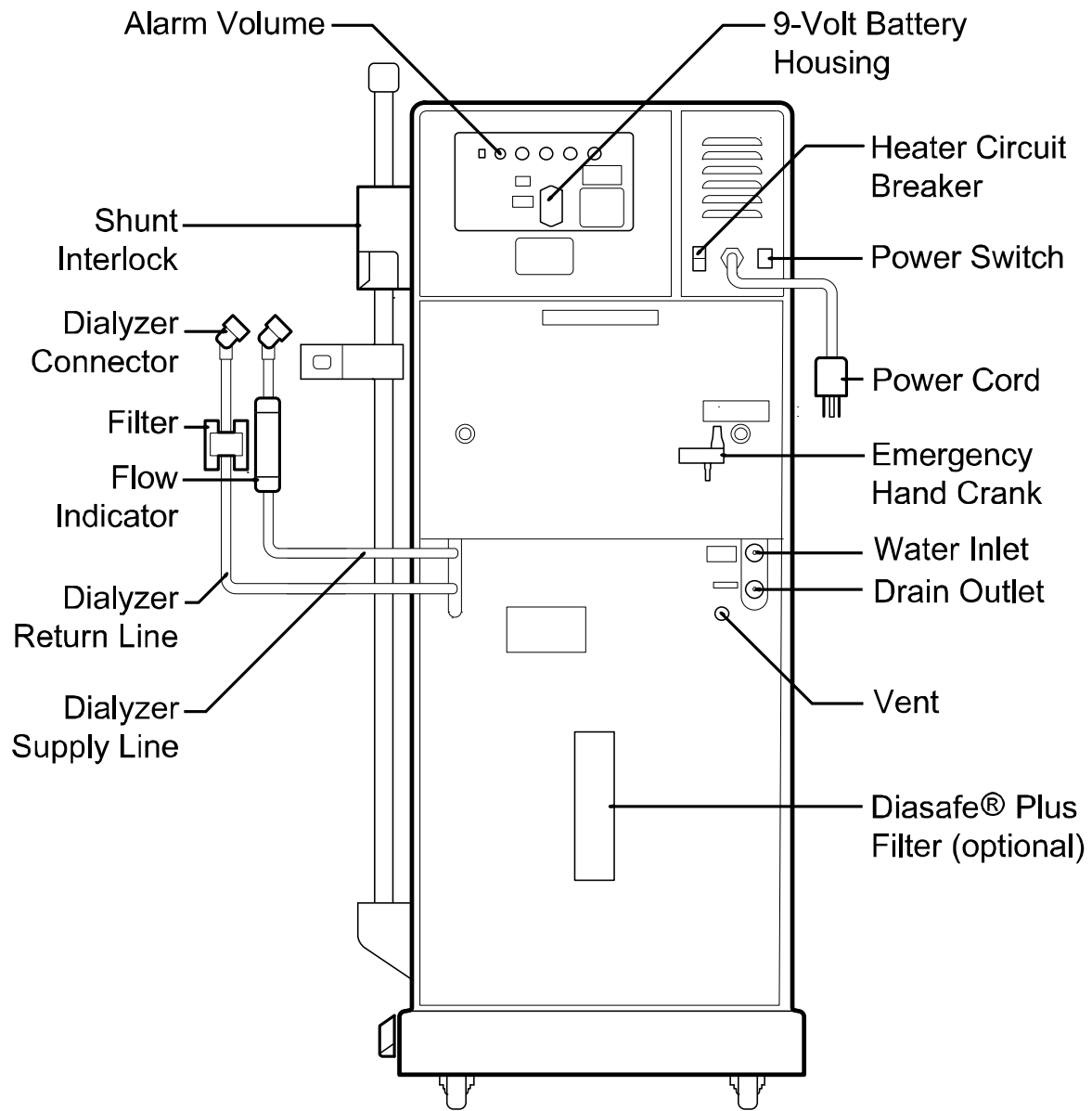

2008K Hemodialysis Machine—Rear View

## Operation Modes

To prepare the 2008K for operation:

1. Press the **POWER** key on the control panel. The green light above the key will light, and the Start-Up screen will appear on the monitor.



---

**Note:** If the machine is filled with disinfectant or Rinse is the only option that appears in the Start Up screen, the machine must complete a rinse cycle before being used for treatment. Touch **Rinse** to start the rinse cycle. Upon completion of rinse cycle test the machine for any residual disinfectant according to the established guidelines of the facility.

---

**Note:** During the power up sequence a message is displayed for a few seconds: “Press Confirm for Service Mode”. If this is done, the machine enters the calibration screens instead of the Start-Up screen.

---

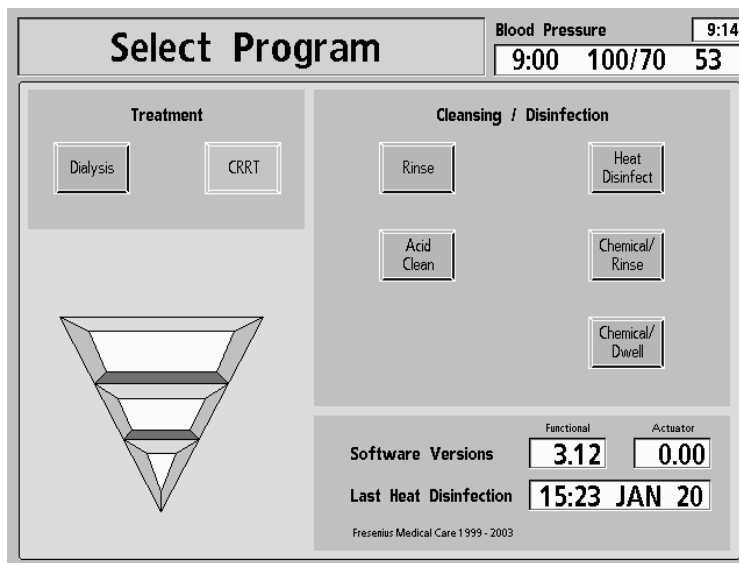

**The Start-Up Screen**

2. Insert the acid concentrate (red) connector into a centralized acid supply or a jug containing sufficient acid concentrate for an entire treatment. If acetate concentrate is being used, insert the red connector into the acetate supply.



---

**Caution:** Be sure the jug contains enough concentrate for the entire treatment. If the jug runs out during treatment, a condition known as “air lock” may occur, causing conductivity problems.

---

3. If the machine is being prepared for normal dialysis, touch the **Dialysis** button on the touch screen. The Dialysate screen will appear on the monitor.

- 4. Verify that the concentrate type, displayed near the top of the screen, correctly matches the prescribed concentrate type, and that the acid/bicarbonate or acetate concentrates connected to the machine match the type selected. If an incorrect concentrate type is displayed, the correct concentrate must be entered.

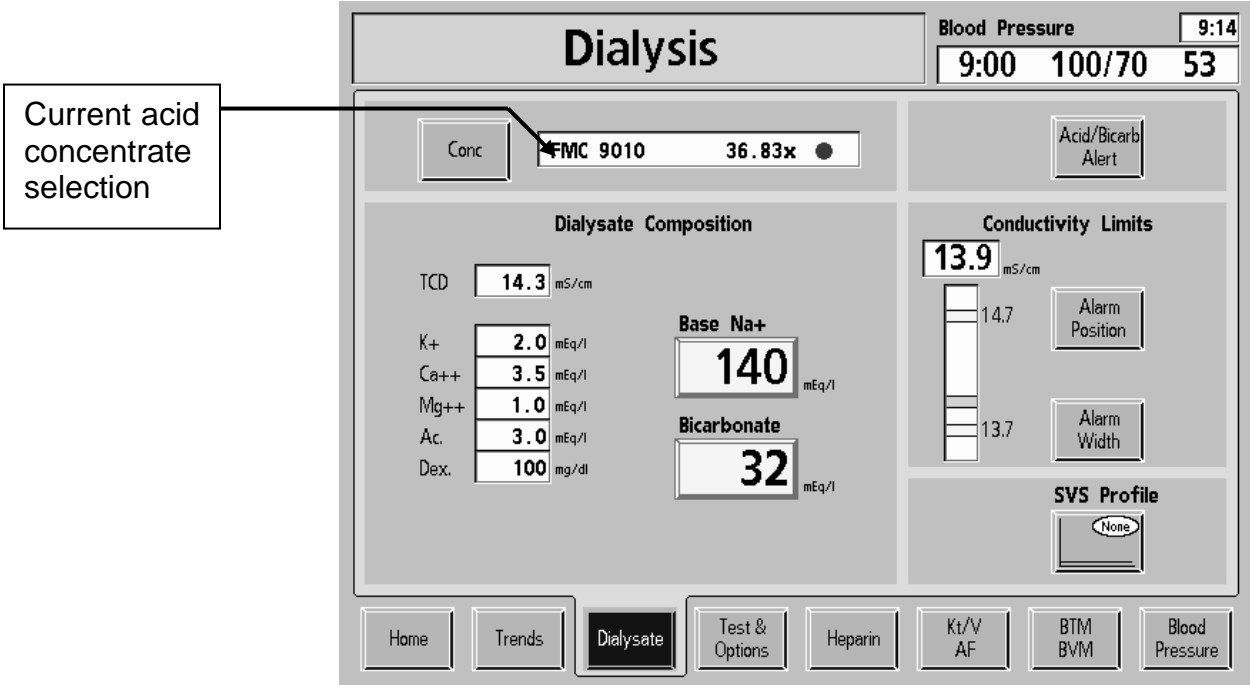

The Dialysate Screen

- 5. After the concentrate displayed is correct, verify that the Base Na<sup>+</sup> and Bicarbonate are as prescribed. Press the **CONFIRM** key, and then touch the **Home** screen-button.
- 6. Insert the bicarbonate concentrate (blue) connector into a central bicarbonate supply or a jug containing sufficient bicarbonate concentrate for an entire treatment. Again, be sure the jug contains enough concentrate for the entire treatment.

## Sodium Variation System

Physicians may prescribe additional sodium in the dialysate to assist in the prevention of hypotension, cramping, and disequilibrium syndrome. The Sodium Variation System (SVS) option provides the operator with an automated method of changing the concentration of dialysate sodium in accordance with the physician’s prescription.

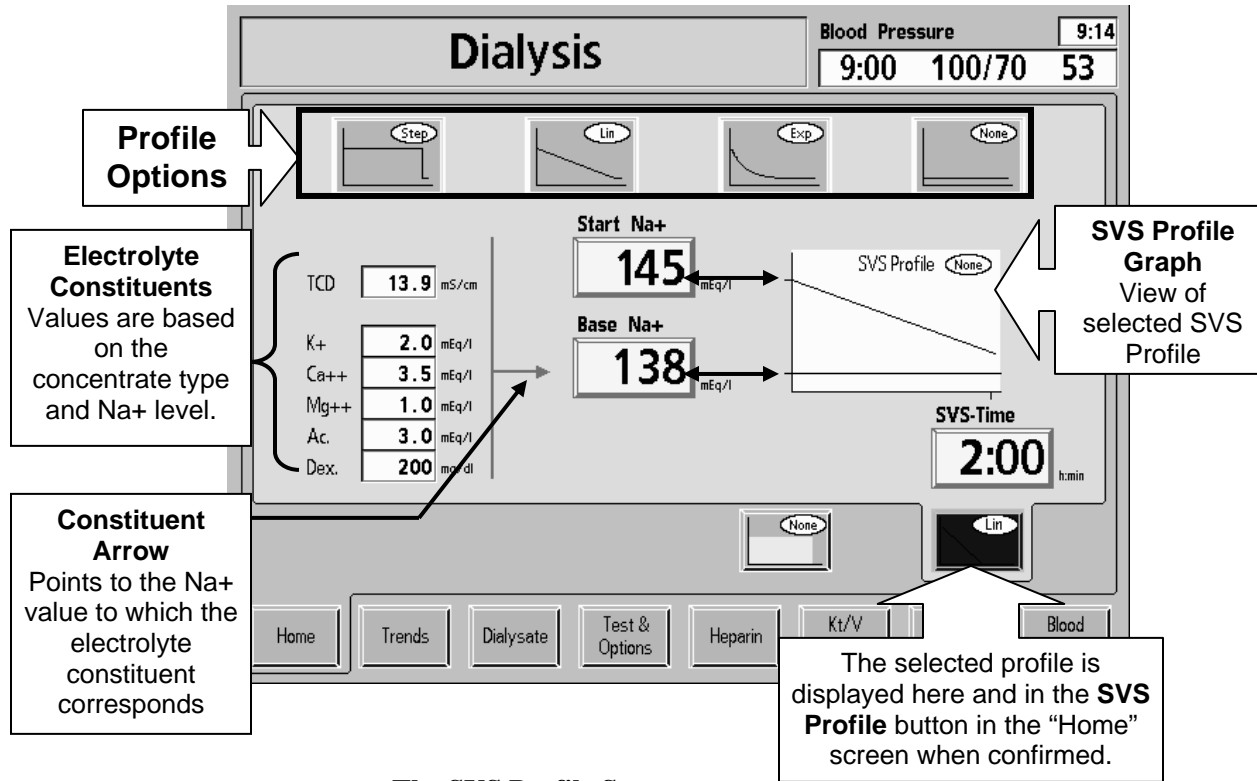

**The SVS Profile Screen**

The Sodium Variation System (SVS) allows the standard dialysis treatment to be modified so that the acid/acetate concentrate, which contains most of the sodium in the dialysate, is varied according to a specific profile. There are three basic profiles available: Step, Linear, Exponential, or None. In each profile, a higher level of sodium (Start Na<sup>+</sup>) is set initially. By the end of SVS operation, the sodium level is back to the Base level. Selecting “None” maintains the sodium at the Base level through the course of the treatment. The profile default is “None”.

The following table describes the buttons on the “SVS” sub screens that facilitate the implementation of the SVS.



**Note:** The constituents concentration is recalculated each time the  $\Delta$  or  $\nabla$  (up or down) arrow key is pressed. If the Na or Bicarbonate level is entered with a numeric key, they are only recalculated after the **CONFIRM** key is pressed or a parameter button is pressed for a different parameter.



## The Control Panel

The control panel is located at the top, front of the 2008K machine and contains key pads that allow the user to control the operation of the 2008K. Located in the middle of the control panel is the touch screen that can display a variety of treatment screens through which the operator can use to set treatment parameters and monitor the treatment.

The touch screen provides a means of setting the treatment parameters and monitoring the treatment and patient status during dialysis. The operator can access treatment screens and set treatment parameters by pressing specific, identified sites (buttons) on the screen. Most numbers and parameters selected on the touch screen must be confirmed by pressing the **CONFIRM** key on the front panel. This feature was designed to prevent a change in a treatment value if the touch screen is accidentally bumped.

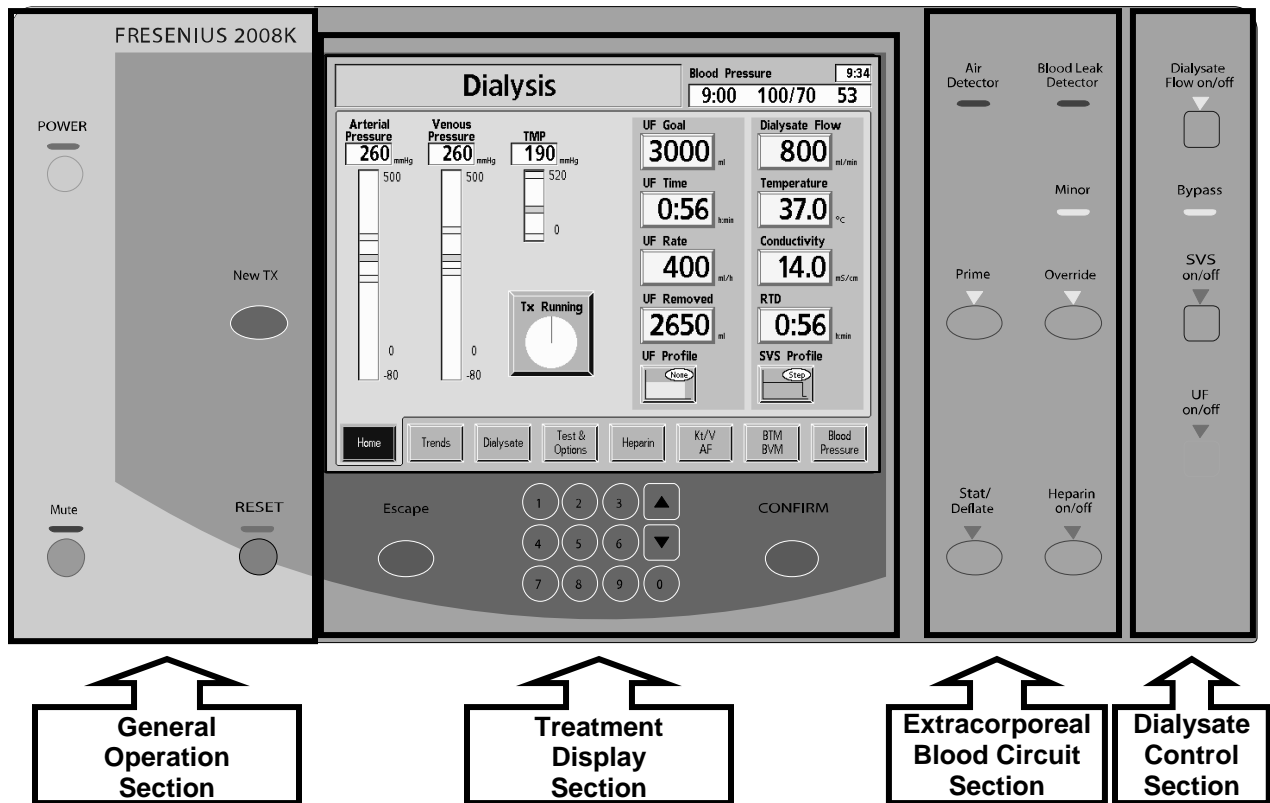

The Components of the Control Panel

## The Control Panel

The Status box appears at the top left corner of every treatment screen. During normal operation it displays operational mode of the machine; Dialysis. During alarm situations, it displays an informational message. It may also prompt the operator for a specific action in situations when the treatment parameters are being set.

To the right of the status box, is the Dialogue Box. During normal treatment, the Dialogue Box displays the current time, the time of the last blood pressure reading and the patient’s blood pressure and pulse rate at that time.

When attempting to enter a treatment parameter that is outside the range of allowable limits, the Dialogue Box displays an advisory message.

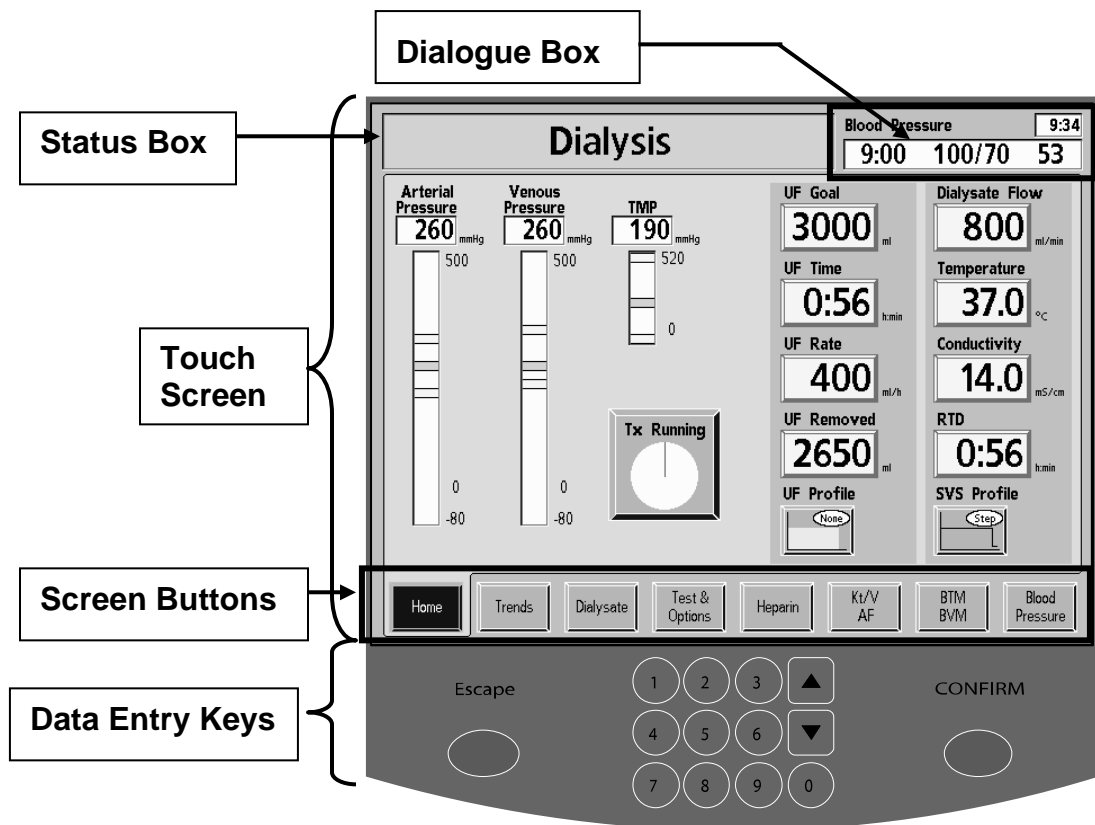

Control Panel – Treatment Display Section

### Test Sequence

To run the Pressure and Alarms tests:

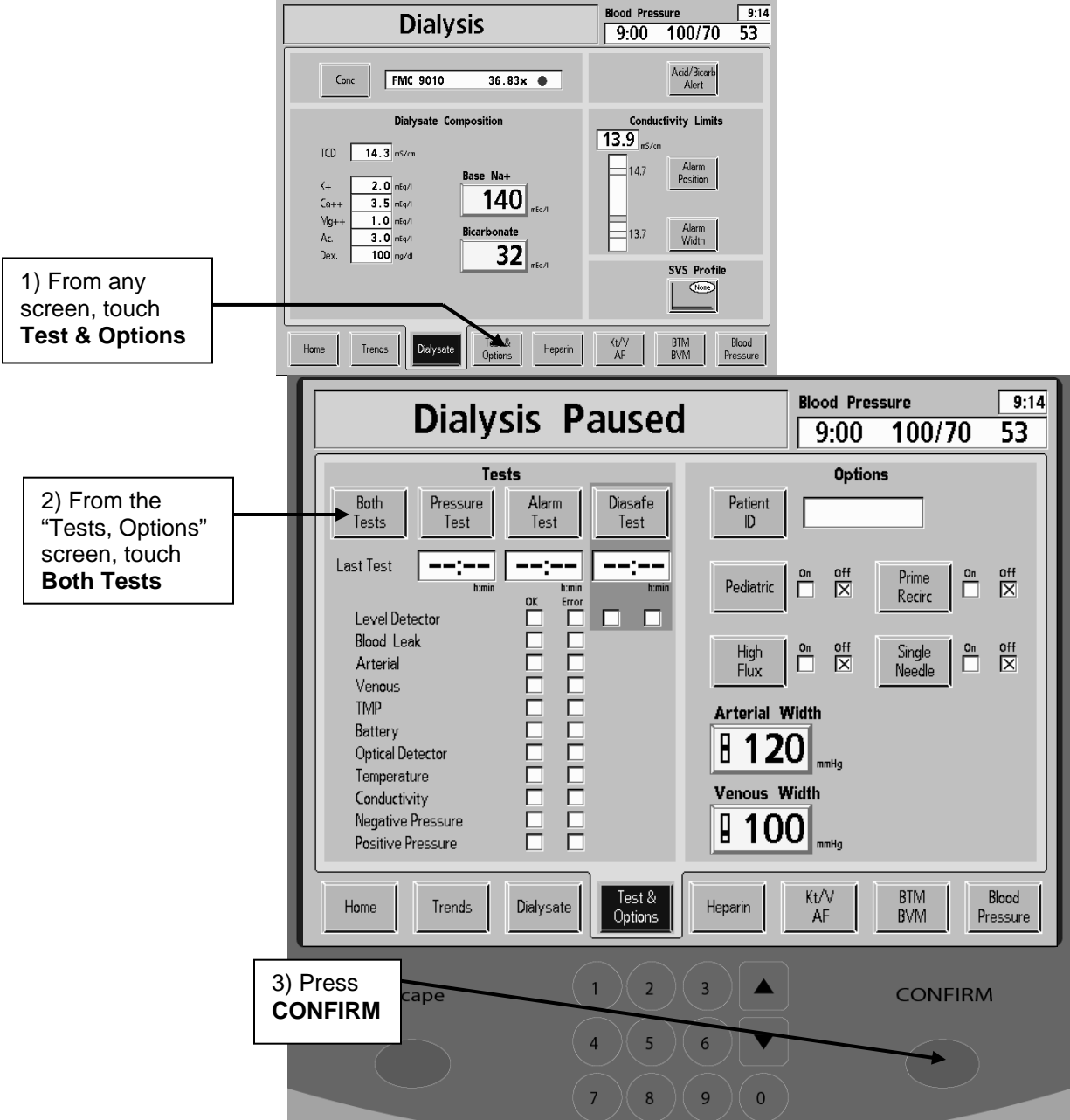

### Starting Automatic Tests

### Test Sequence

The automated test sequence consists of two distinct parts—Alarm tests and Pressure Holding tests. The Pressure Holding Test, the Alarm test, or both tests can be started by touching the corresponding button on the “Test & Options” screen and pressing the **CONFIRM** key. After a long power down, however, only the **Both Tests** button is enabled.

## Online Clearance

### How Kt/V is Derived

Online Clearance (OLC)—used in estimating the effectiveness of the dialysis treatment—can be viewed in the “Kt/V” screen. The effectiveness of the treatment is based on the amount of urea that is removed from the patient’s blood. It has been shown that sodium can be used as a surrogate to urea for determining removal rates (clearance). The key to determining the amount of urea cleared is based on the fact that urea clearance is almost identical to sodium clearance.

To measure the effectiveness of treatment, the concentration of sodium in the dialysate is adjusted for a brief duration. This changes the conductivity of the dialysate. The conductivity of the dialysate is then measured before and after it passes through the dialyzer. As the dialysate passes through the dialyzer, some of the sodium diffuses through the membrane resulting in a different, post-dialyzer, conductivity reading. The amount of sodium clearance (K<sub>ecn</sub>) can be calculated based on the change in conductivity of the dialysate after it passed through the dialyzer.

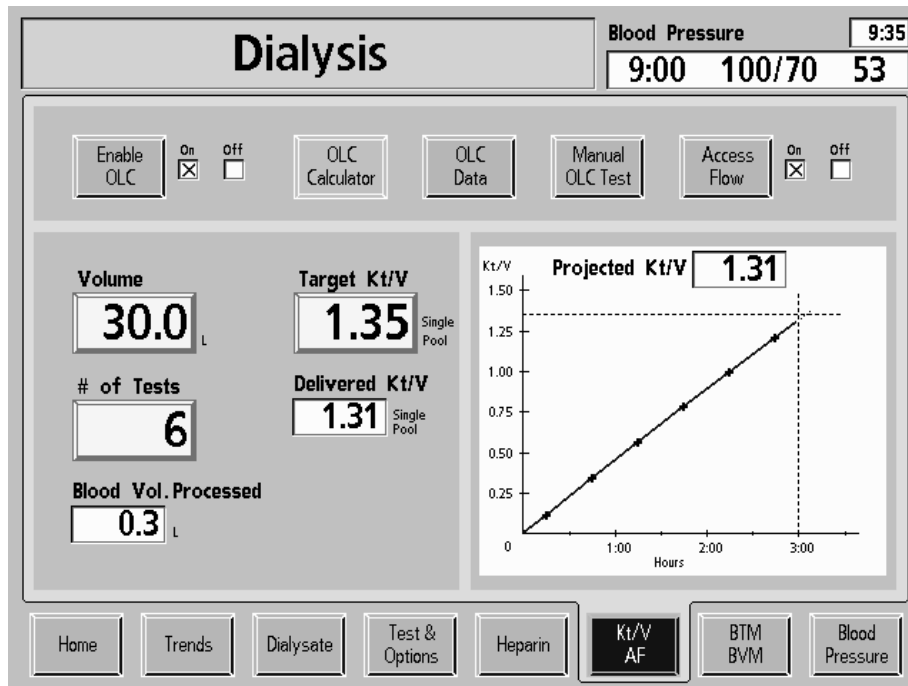

**The Kt/V and Access Flow Screen**

The following table describes the features found in the “Kt/V” screen on machines with active OLC functionality.



**Note:** If the OLC functionality has been deactivated (in the Service Mode) on your machine, all features will be inactive and appear grayed out.

## Diasafe Filter

The Diasafe Plus filter is intended for the preparation of ultra-pure dialysate. If the machine has a Diasafe Plus filter, it should be replaced at least every 90 days (3 months). You must also replace the filter if the Diasafe test fails or shows an external leak. To replace the Diasafe Plus filter:



---

**Warning!** The use of the Diasafe Plus filter does not reduce the need for routine disinfection of your machine and RO system or routine monitoring of the chemical and bacterial water quality. The disinfection procedure is unchanged with the Diasafe Plus filter installed.

---



---

**Warning!** The Diasafe Plus filter can only be used in Fresenius Medical Care hemodialysis machines fitted with Diasafe Plus Diafix lock system kits.

---

**Note:** If you instead have the DIASAFE Filter (located inside your machine), refer to P/N 490039: Diasafe Filter Operator's Instructions.

---

1. Lift up the lock levers on the left side of the filter mount and slide used Diasafe Plus filter up and out. Follow your clinic's instructions for disposal.
2. Fit the fresh Diasafe Plus filter in the groove at the top of the mount and slid it down until it clicks into place. Push the lock levers down again to lock the filter into its mount.
3. Test the new Diasafe Plus filter: From the "Test & Options" screen, select the **Pressure Test** button and press **CONFIRM** to start the test. When the Pressure Holding test has passed, touch the **Diasafe Test** button and press **CONFIRM** to start the test.



---

**Warning!** If the machine fails any of the tests and the cause cannot be corrected, or if it fails later tests, it should not be used for treatment. Have the machine checked by a qualified technician to correct the problem.







---

**Warning!** After replacing the Diasafe Plus filter, run a Heat Disinfect to disinfect the machine.

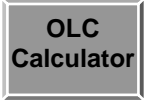
---

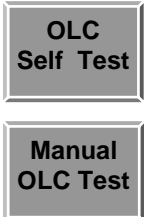
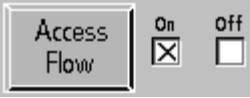
## OLC “0” Test

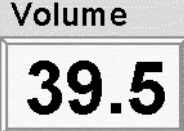
The Kt/V Screen Buttons and display

Button	Function
	<p>This button activates and deactivates the OLC option as indicated by the check box to the right. By default, OLC is enabled.</p>
	<p>This button brings up the OLC Calculator—a useful tool for estimating the treatment effectiveness and time required based on various treatment parameters. (Not available at this time).</p>
	<p>Touching the <b>OLC Data</b> button opens the “OLC” subscreen that provides the actual results of each OLC test.</p>
	<p>This button changes functions based on the machine status.</p> <p>When there is no blood sensed and the blood pump is stopped or the dialysate lines are on the shunt, touching this button followed by the <b>CONFIRM</b> key initiates the OLC Self Test.</p> <p>When blood is sensed, an unscheduled clearance test is initiated. The manual test takes the place of one of the scheduled test entered in the <b># of Tests</b> button.</p>
	<p>This button is used to allow the Access Flow test to be performed. When it is turned On, the machine will offer to do the Access Flow test following the next OLC test. If it is inconvenient to do the test early in the treatment, this button may be left in the Off position and turned On when it is convenient. Touch the <b>Manual OLC Test</b> button and press <b>CONFIRM</b> after turning on the Access Flow to begin the process right away. When the test is initiated, the operator is guided through the steps necessary to perform the test.</p> <div style="border: 1px solid black; padding: 5px; margin-top: 10px;">  <p><b>Warning:</b> To avoid the possibility of significant blood loss, be sure that the connections are well secured after disconnecting and reconnecting the bloodlines.</p> </div>
	<p>The patient's, urea-distribution volume (in liters) is entered here. This value should be determined using urea-kinetic values. Anthropometric formulae may give different results than kinetically calculated urea-distribution volume.</p>
	<p>The prescribed target single-pool value, ranging from 0.40 to 2.50, is entered in this button. This value is reset to the default value when the <b>New Tx</b> key is pressed. The default value may be changed in Service Mode.</p>

**OLC “0” Test**

**DEBUG SCREEN 5 - ON-LINE CLEARANCE**

5 ON-LINE CLEARANCE				Blood Pressure		11:08
				9:00	100/70	53
ACOND	AFREQ	TPRE	TPOS	Qd	AF1	Pre Dev val
0	0	3700	3700	0	0	0
Pre Offset	Pre Slope	FPRE	CPRE	Qb	AF2	Pre Stbl Ct
2392	2.05	10800	10000	0	0	0
Post Offset	Post Slope	FPOS	CPOS	Qf	AF3	Pre % Stbl
19977	0.00	10800	10000	0	0	4
CREF	OLC CalcSt	OLC status	OLC Enable	Qdl	0 test	Post Dev val
14321	0	0	1	0	0	0
St Pre-cond		CPRE Stable	CPOS Stable	QdS	Current TI	Post Stbl Ct
0		0	0	0	0	0
St post-cond		Up Steps	Down Steps	QbS	Avg TI	Post % Stbl
0		0	0	0	0	5

Home	Trends	Dialysate	Test & Options	Heparin	Kt/V AF	BTM BVM	Blood Pressure
------	--------	-----------	----------------	---------	---------	---------	----------------

- When the OLC Self Test is complete, go to debug screen #5 and confirm that 0 Test (OTST prior to functional software version 3.02) is in the range  $\pm 20$ .



**Note:** If 0 Test (OTST) is out of range, the OLC Self Test will fail. If this happens, conduct temperature (PRE & POST) and conductivity calibrations, then conduct OLC Self Test again.

## Concentrate Select Menu

### What to do from this screen...

Enter the prescribed dialysate settings for:

- Concentrate type
- Base Na<sup>+</sup> level
- Bicarbonate level
- Sodium Variation (SVS) profile

Set Alarm limits for:

- Low Acid/Bicarbonate warning
- Position and width of Conductivity Alarm window



**Warning!** The specific concentrate and sodium and bicarbonate settings must be prescribed by a physician.

The screenshot shows the 'Dialysis' screen with the following components and callouts:

- Concentrate Type:** A callout box points to the 'Conc' field displaying 'FMC 9010 36.83x'.
- Theoretical Conductivity (TCD):** A callout box points to the 'TCD' field displaying '14.3 mS/cm'.
- Electrolyte Profile of Selected Concentrate:** A callout box points to the electrolyte table below the TCD field.
- Alarm Window:** A callout box points to the 'Base Na+' field displaying '32 mEq/l'.
- Conductivity Scale:** A callout box points to the 'Conductivity Limits' section, which includes a vertical scale with markers at 13.7 and 14.7.
- Actual Conductivity:** A callout box points to the 'Actual Conductivity' field displaying '13.9 mS/cm'.

The screen also displays 'Blood Pressure' (9:00 100/70 53) and '9:14' in the top right corner. At the bottom, there is a navigation bar with buttons for Home, Trends, Dialysate, Test & Options, Heparin, Kt/V AF, BTM BVM, and Blood Pressure.

The Dialysate Screen



## UF Profile Menu

To enter an ultrafiltration profile:

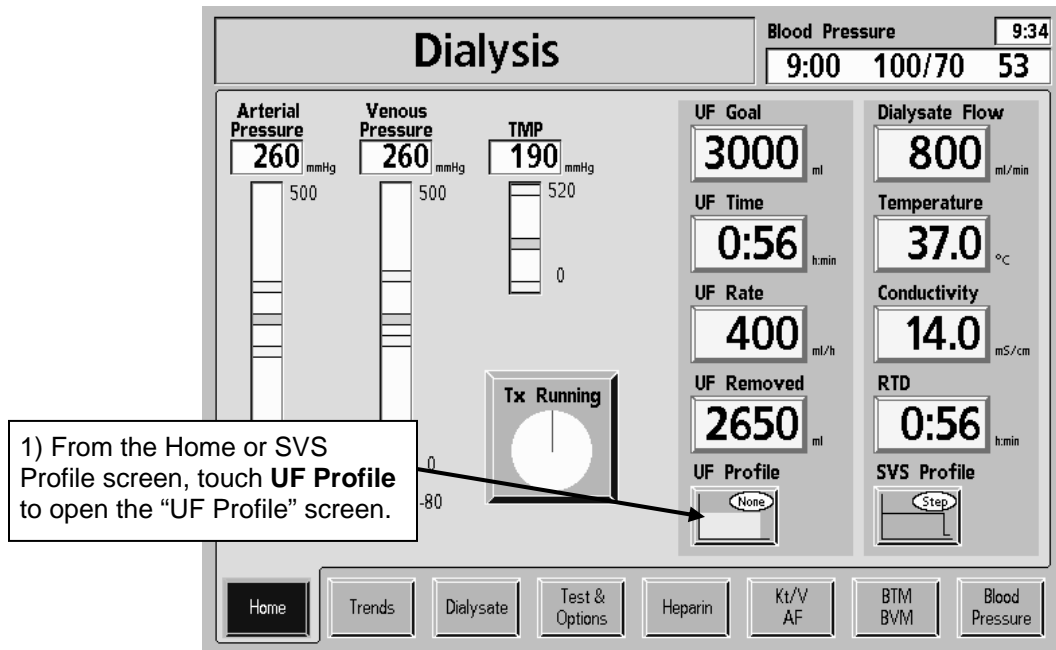

Setting a UF Profile

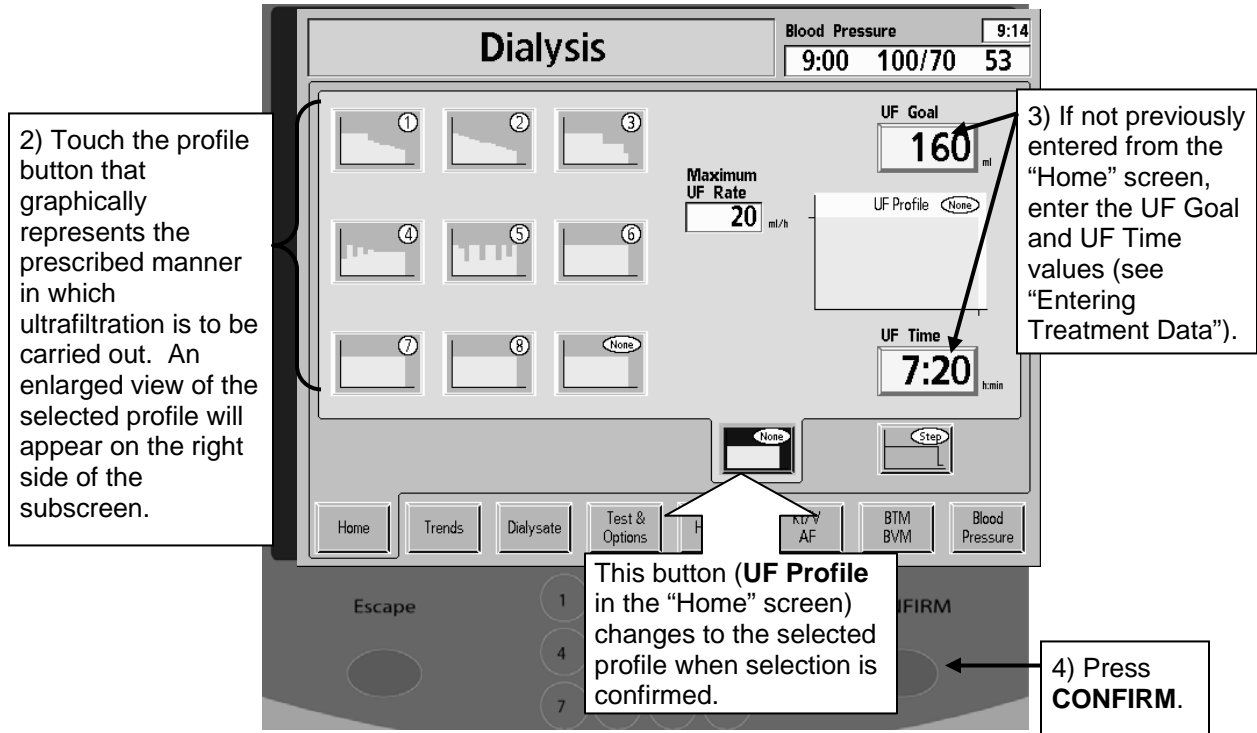

Setting UF Profile Parameters

## Blood Pump Module

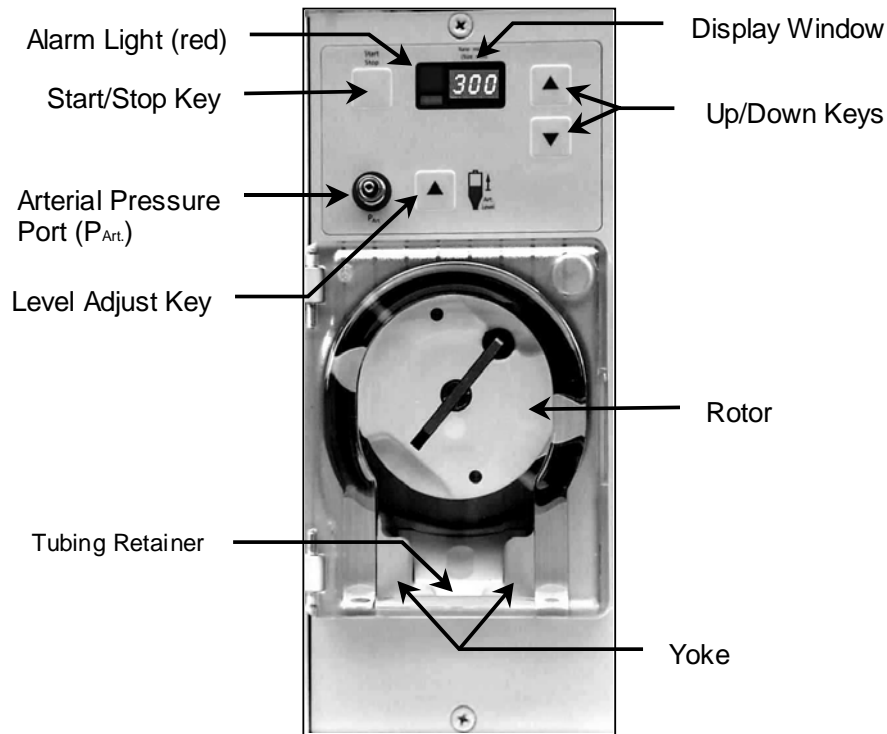

**The Blood Pump Module**

The following table describes the operational features of the blood pump.

### Blood Pump Features

FEATURE	PURPOSE
Start/Stop Key	Starts and stops the blood pump. Opening the door will also stop the blood pump.
Pressure Port	Line from arterial drip chamber is connected to a transducer protector and attached here to provide arterial blood pressure readings
Level Adjust Key	Pressing the $\Delta$ key (level adjust key on the Level Detector module) will raise the level of the blood in the arterial drip chamber.
Display Window	Displays the blood flow rate setting in increments of 5 ml/min during blood pump operation. When the door is open it displays the pump-segment diameter in mm.
Up/Down Keys	Increases the speed of the pump when Up arrow ( $\Delta$ ) is depressed, decreases the pump speed when Down arrow ( $\nabla$ ) is depressed. When door is open, simultaneously press the $\nabla$ and $\Delta$ keys and then press the $\nabla$ or $\Delta$ key to adjust pump segment diameter.
Tubing Retainer	A spring-loaded device that secures the pump segment in place.

## Level Detector Module

The Level detector module is used to monitor the level of blood in the venous drip chamber. The venous drip chamber is mounted inside its holder and the blood tubing leading back to the patient is threaded through the venous line clamp below it. An ultrasonic device inside the chamber holder monitors the drip chamber for the presence of air. If the level of blood in the chamber is too low and air is detected, the clamp occludes the venous blood tubing.

An optical sensor located below the occlusion clamp recognizes whether or not blood, an opaque fluid, is detected in the venous line. When the dialysate supply lines are on the shunt, and the shunt door is closed, and blood is not sensed, the audible alarm is suppressed entirely.

Also located on the front of the module is a pressure port. The small monitor line from the drip chamber is connected to the transducer port. The pressure of the venous side of the blood circuit is read by the transducer mounted on the inside of the module, and the pressure is displayed in the “Home” screen.

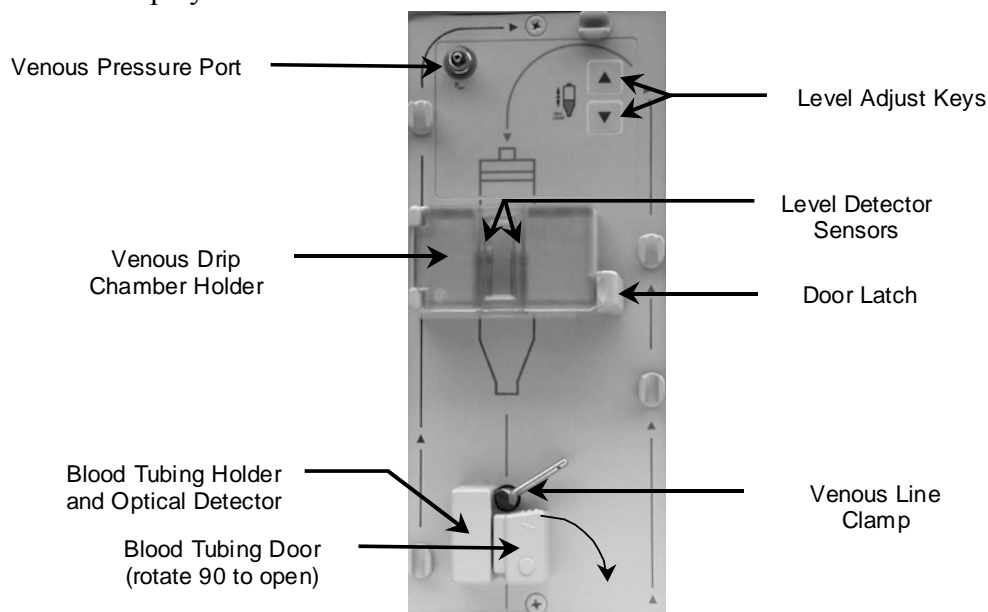

**Level Detector Module**

### Level detector features

FEATURE	PURPOSE
Venous Pressure port ( $P_{ven.}$ )	Line from venous drip chamber is connected to a transducer protector and attached here to provide venous blood pressure readings.
Venous Drip Chamber Holder	Holds the drip chamber and aligns it with the ultrasonic air sensor. Latching door secures chamber in place.

Section IV – Machine Operation

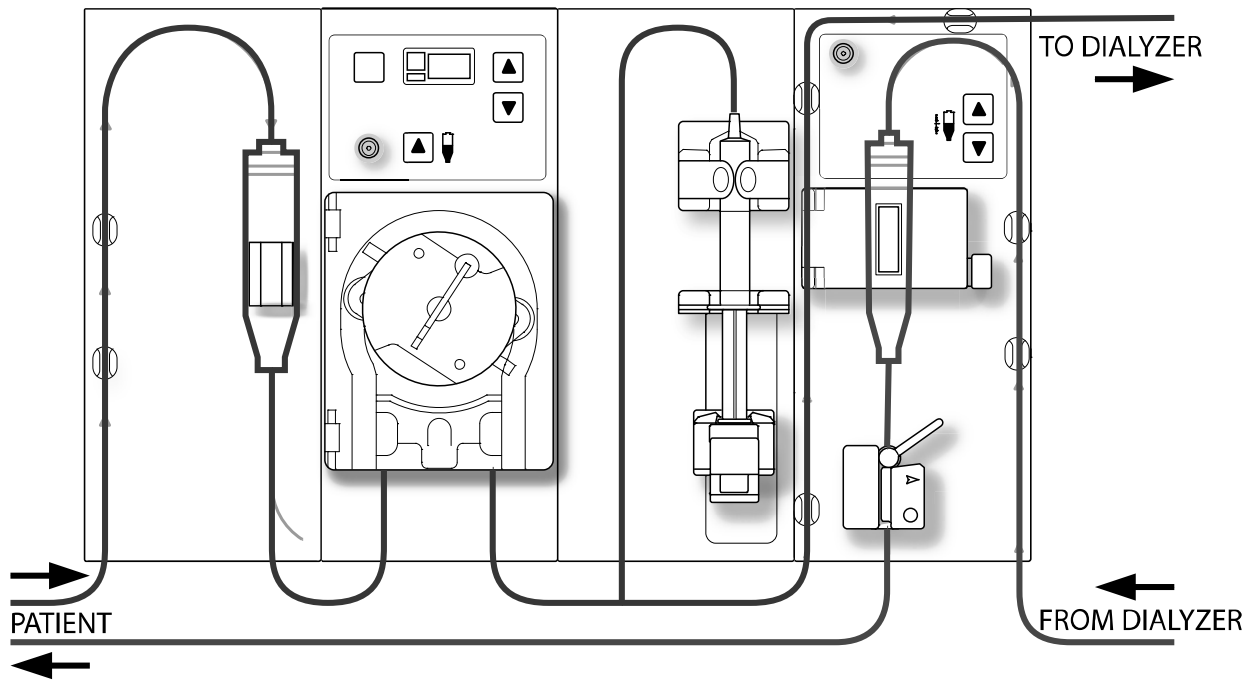

**Pre-pump Arterial Chamber Configuration**

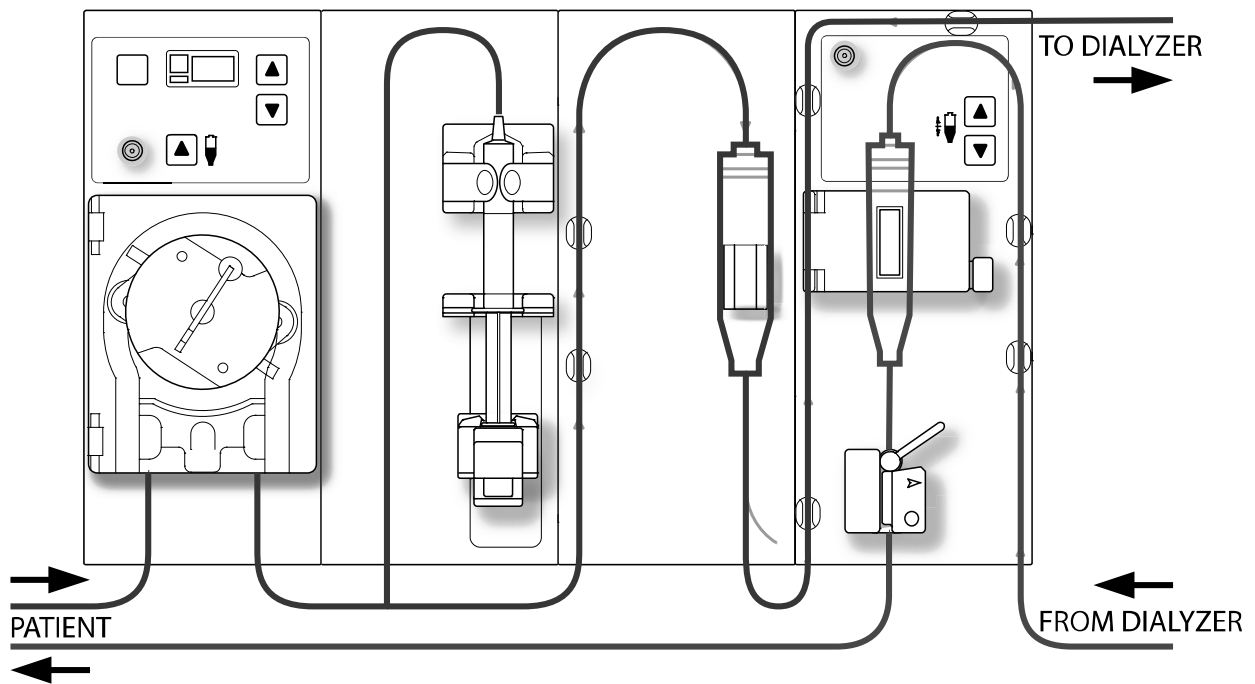

**Post-pump Arterial Chamber Configuration**





**S E C T I O N V**

**INSTALLATION CHECKLIST  
INSTRUCTIONS**









**SECTION VI**

**ELECTRONIC CIRCUIT BOARD  
REVIEW**







## Electronic Circuit Board Review

### **Warning !**

### **Electro Static Discharge PRECAUTIONS REQUIRED**

#### Power Supply

- Incoming power is stepped down to 24 Volts DC
- Heater Triac
- Power Cords
  - Connects machine to 120V AC power source
  - Provides 120V AC to Heater connections in distribution board
- Power Control Board
  - 12 Volt Standby
  - Heater Relay
  - 24 Volt Relay
  - Mains Fuses (6.3 Amp)

#### Power Logic Board

- Machine Power On Signal From Power Button
- Modified versions ( H – K & now with -12V inverter incorporated (see below))
- Auto Off option
- 9 Volt Battery Test
- DC to DC Converters (+5 & +12 Volt DC “regulators”)
- Heater Control signals
- Alarm Tones Generated

#### Actuator & Actuator / Test combination Board

- Drives Pumps, Valves & Motors for Hydraulic control
- Has It’s Own Analog to Digital Converter
  - **ADC** for communication with Functional board
- Own software
  - *Electronically Erasable Programmable Read-Only Memory* EEPROM
  - Software version not compatible between machine models.
- Secondary Monitor for Hardware Alarm Limits

#### \*Actuator / Test Combo board **TEST** circuit\*

- Used during POST (Power On Self Test)
- Runs Alarms Test

## Electronic Circuit Board Review (cont.)

### Functional Board K/K2

- Controls all machine Functions (MPU)
- Watchdog Circuit
- Calibration EEPROM
- LCD Drivers
- Software Upgrades are performed using a PAL, PC, or Laptop.
- All Options are set in Service Mode
- Runs Pressure Holding Tests
  - Negative Pressure
  - Positive Pressure

### UI / MICS / CDX board -**T machine ONLY!**

- UI = User Interface / MICS = Medical Information Computer System / CDX = Clinical Data Exchange
- Will be in the fourth position from the left in the card cage. The user interface board interfaces the display screen, keyboard, keypad and touchpad with the motherboard. The user interface board transfers screen data from the functional board and up-scales it to the 15 inch LCD display. The user interface board also handles the keypad keys and the touchpad circuitry.
- UI portion provides interface between user input and electronic control (Functional board)
- MICS & CDX portion incorporates vendor software installed on the internal flash drive to manage medical information collected or entered during treatment

### Test Board

\*NOTE\* will not be present if machine equipped with Actuator / Test Combo Board (see above)

- Used during POST (Power On Self Test)
- Runs Alarms Test
- EPROM software

### Sensor Board

- Primary Monitor Board
- 2008K/K2 use ONLY sensor board with OLC
- Has Primary Analog to Digital Converter for communication with the Functional Board



## Electronic Circuit Board Review (cont.)

### Motherboard

\*NOTE\* K/K2 Motherboards manufactured post September 2007 have additional pin connections (3<sup>rd</sup> row pins connected @ Act. /Test combo board).

- Connections for and communication between circuit boards in card cage.
- Remote connections for Modules.
- Main 24 Volt Power cable connection.
  - Must be plugged in completely!

### -12 Volts Inverter

\*NOTE\* This board may be incorporated into the Power Logic board (see above)

- Used by Colin Module
  - NIBP
- Used by 2008 H/K machines with OLC

### Display assembly 2008K

- LCD Display
- Display interface board
- Front Panel Switch Matrix
- Touch Screen

### Display assembly 2008K2

- LCD Display
- Display interface board
- New Front Panel Assembly with additional switch matrix buttons
  - + / – Keys
  - Directional arrow keys around ‘CONFIRM’ button



# **SECTION VII**

## **ALARMS & PRESSURE HOLDING TESTS**







### **Alarms & Pressure Holding Tests**

- There are several different types of tests to choose from
- Before patient treatment the Alarms Test and the “Big” Pressure Holding Test (PHT) should be done according to unit protocol
- A separate On-Line PHT can be done during patient treatment

### **Alarms & Pressure Holding Tests**

- Alarms and Pressure Holding Tests must both be done before either test can be run independently.
- After the first tests have run, Alarms or PHT can be selected as long as power is not lost for more than two minutes
- The On-Line PHT is an optional Test that runs throughout the patient treatment

### **Test Start Criteria / “BIG” Test**

- Certain conditions must be met for the test(s) to start.
- Must be in Dialysis Mode w/ dialysate lines on the shunt and the door closed
- Venous dummy chamber in place / clear all blood and dialysate (water) alarms
- Venous & Arterial pressure reading @ zero
- No blood sensed and no UF or SVS programs initiated

### **Start the “BIG” Test**

- Select the Test & Options button at the bottom of the screen. On this screen press Both Tests button. Press [CONFIRM] key to start.
- Observe the machine as it steps through the test sequence.

### **Alarms Test**

- For Arterial, Venous, TMP, Temperature and Conductivity tests there are four tests
- Hi / Lo & Hard / Soft
- The Hi and Lo are the upper and lower limits
- The Hard Limits are controlled by the Actuator Board
- The Soft Limits are controlled by the Functional Board

### **Three Steps to each individual Test – Generated by the Test Board**

- 1) Create the alarm condition
- After the alarm is created a timeout clock will cause a test failure if the alarm is not confirmed
- 2) Confirm the alarm condition
- 3) Reset the alarm
- Once confirmed a timeout clock will cause a test failure if the alarm is not reset

### **Alarm Test Confirmations**

- For all Blood Alarm Tests there are two confirmation signals
- 1) Blood Pump Stops
- 2) Venous Line Clamp On
- For Dialysate (water) Alarms Test the confirmation is...
- **BYPASS!!! VALVE 24 CLOSED?**

### **Test of the Optical Detector**

- For all Blood Alarm Tests there are two confirmation signals
- 1) Blood Pump Stops
- 2) Venous Line Clamp On
- During this test the Test board wants to “see” a Lower Venous Alarm indication
- Blood sensed is simulated and the lower venous limit is shifted up to zero. With no patient connected and venous pressure @ zero, a lower venous alarm should be generated

### **9Volt Battery Test**

- A 22  $\Omega$  Load is placed across the battery
- Battery voltage must be > 7.0VDC for the test to pass

### **Pressure Holding Test**

- As part of the “BIG” test the pressure holding test is done in dialysis mode with the lines on the shunt & door closed.
- This test is usually done prior to patient treatment
- The On-Line PHT is an optional test that runs during the patient treatment (to be discussed later).



## PHT Steps

1. Remove Air – Fill Program is performed even if no air is sensed to insure proper pressure reading during the test
2. Get negative TMP –  $TMP = P_{ven} - P_{DIAL}$ . After a positive pressure is achieved the UF pump is used to generate a  $TMP \approx 270$  then UF is turned off and 30 second stabilization is allowed.
  - TMP must stabilize between (250 – 450)
  - If the TMP does not stabilize in this range a message “Failed Stabilization” will be displayed
  - If stabilization fails stop and troubleshoot to determine the cause
  - Resume PHT after stabilization issue resolved
3. Negative Flow On TEST– this is the first actual “pressure” test during the PHT. TMP must remain stable during this test and not change by more than +/-20mmHg. This is a dynamic test for 30 seconds (hydraulics in motion). The TMP has been pumped up to a high pressure in between 250 – 450 and must not fluctuate within those parameters.
4. Get positive TMP – in this step the fresh valves are used to generate positive pressure @ the  $P_{DIAL}$  transducer. A pressure of at least +350 is achieved, and then the pressure is reduced to +250.
  - After positive pressure is achieved a 20 second stabilization is allowed and TMP must remain within the range of (+180 - +350)
5. Positive Flow Off Test - Once a positive pressure has been achieved the flow is turned off and the TMP is monitored. The tolerance for positive flow off is +/-30mmHg. The test is for 30 seconds.
  - Only a hydraulic secondary leak will affect  $P_{DIAL}$  reading during this test
  - A leak in the primary or the balance chamber would not be felt @ the  $P_{DIAL}$  transducer unless two balance chamber valves were leaking on the same side of the balancing chamber
  - If negative flow on failed and positive flow off passes – then the problem is most likely located in the primary hydraulics or the balancing chamber.
6. Get Negative TMP - normal cycling is started and a  $TMP > 0$  must be reached during this step. The UF pump may stroke during this step to achieve the proper pressure
7. Testing - during this step the machine is monitoring the system to insure all is normal
8. Test Complete / Failure Message



## SECTION VIII

### **ON-LINE PRESSURE HOLDING TEST**



## 2008K On-Line Pressure Holding Test (PHT)

- When the option is on, the test will run in dialysis mode every 12 minutes
- The patient dialyzer is isolated from the machine hydraulics
- The test lasts for two complete balance chamber cycles
- The dialysate pressure transducer is monitored
- $P_{DIAL}$  must not fluctuate by more than  $\pm 30$ mmHg for the test to pass
- The on line pressure holding test starts with 35,38,32,33 closed (PHT 0).
- The 2nd cycle is 36,37,31,34 closed (PHT 1).
- The results of the on line PHT are displayed on the debug screens (screen 17 on the H and screen 1 on the K).
- PHT 0 is the first set of valves closed (35, 38, 32, and 33).
- PHT 1 is the second set closed (36, 37, 31, and 34).
- If the on line PHT failed, you have it down to one of 4 valves by looking at the results.
- If PHT 0 failed, it would be one of the valves that are closed, 35, 38, 32, or 33.
- If PHT 1 failed then it would be 36, 37, 31, or 34.
  
- To manually initiate the On-Line PHT for troubleshooting
- Enter the Debug screens by pushing the up and down arrows on the front panel together at the same time.
- Scroll to Debug screen 1 – to activate On-Line PHT press and hold the #1 key on the number pad until the On-line test starts



# **SECTION IX**

## **TROUBLESHOOTING PRESSURE HOLDING TESTS**









## Troubleshooting Pressure Holding Tests (PHT)

Purpose of the PHT is to test the integrity of the machine hydraulics

PHT Failures are an indication of a Leak (internal or external) within the system

**Initial Checks** First check for any PHT failure should be the deaeration pressure

- -24inHg?



**Note:** When the machine is at a different elevation above sea level, it may be difficult or impossible to achieve -24inHg. The following table will help in determining the appropriate deaeration pressure calibration point at different elevations:

Elevation	Approx. atmospheric pressure	Minimum target deaeration pressure relative to atmospheric pressure
feet	mmHg	inches of Hg
0	760	-24.0
1000	728	-23.0
2000	697	-22.0
3000	667	-21.0
4000	639	-20.0
5000	612	-19.0
6000	585	-18.5
7000	561	-17.5
8000	537	-16.9
9000	514	-16.2
10000	492	-15.5

- Visual inspection for obvious leaks – look and feel for leaks and any missing or broken hose clamps
- Check the bicarbonate tip o-ring & acid tip on OLC or Universal Hydraulics machines

## *Section IX – Troubleshooting Pressure Holding Tests*

### **Leaks to Atmosphere**

- If  $P_{\text{DIAL}}$  is negative - Air will be drawn into the machine causing “Air Fill” Programs
- If  $P_{\text{DIAL}}$  is positive - There will be a physical drip or puddle developing. It may not be large enough to “see” easily

Common sources for leaks to atmosphere include but are not limited to – the dialysate o-rings, V43, Air Separation Chamber 69, Bicarbonate tip o-ring, poor deaeration, and any tubing or connection.

## Induced Positive Pressure Tests – Section in Troubleshooting Guide

In Dialysis Mode

Unplug one of the wires for Probe #6 to create a fill program

A Filling Program should be indicated in Debug as FILACT = 1

During fill program Spent outlet valves 32 & 34 are closed.

Clamp the clear tube on Valve #43 output.

With the machine in this state, there should be a FLOW ERROR & TMP should be >+200

The most important step in this procedure is to...

**WAIT!!!**

7 to 10 minutes and “LOOK” for a leak

## Deaeration Problems – Section in Troubleshooting Guide

1. In Dialysis Mode - Turn the flow off
2. Access the distribution panel and disconnect #5. On the male pins in the distribution board use a jumper wire to connect pins 1 (top) and 3 (middle).
3. The Hydroblock will fill. Wait until there is flow out of the vent tube.
4. With flow out the vent clamp the vent tube to create positive pressure in the hydroblock. Leave the jumper in place for less than one minute and look for leaks around the hydroblock.

### Leaks to Negative Pressure

- During the Negative Flow On PHT the TMP will continue to increase toward the maximum reading of 520mmHg with Leaks to Negative Pressure
- If Negative Flow On FAILS & Positive Flow Off PASSES then... A SPENT Balance Chamber Valve could be the cause of the problem if initial checks were done

Summary – Negative Failing with TMP rising possible SPENT Balance Chamber Problem

### Leaks to Positive Pressure

- During Negative Flow ON PHT the *TMP will continue to decrease* toward a reading of zero with **Leaks to Positive Pressure**
- If Negative Flow On **FAILS** & Positive Flow Off **PASSES** then... A **FRESH Balance Chamber Valve** could be the cause of the problem if initial checks were done.

Summary – Negative Failing with TMP dropping possible FRESH Balance Chamber Problem

### Valves not Tested during Big PHT

- Valve #30, #24, & #25 are open during the “Big Test” and therefore are not being “tested”.
- Valve #26 is closed but we have the same pressure on both sides so, no leak can be detected! Valve #26 leaking will not cause PHT test to fail.







# SECTION X

## NOTES









